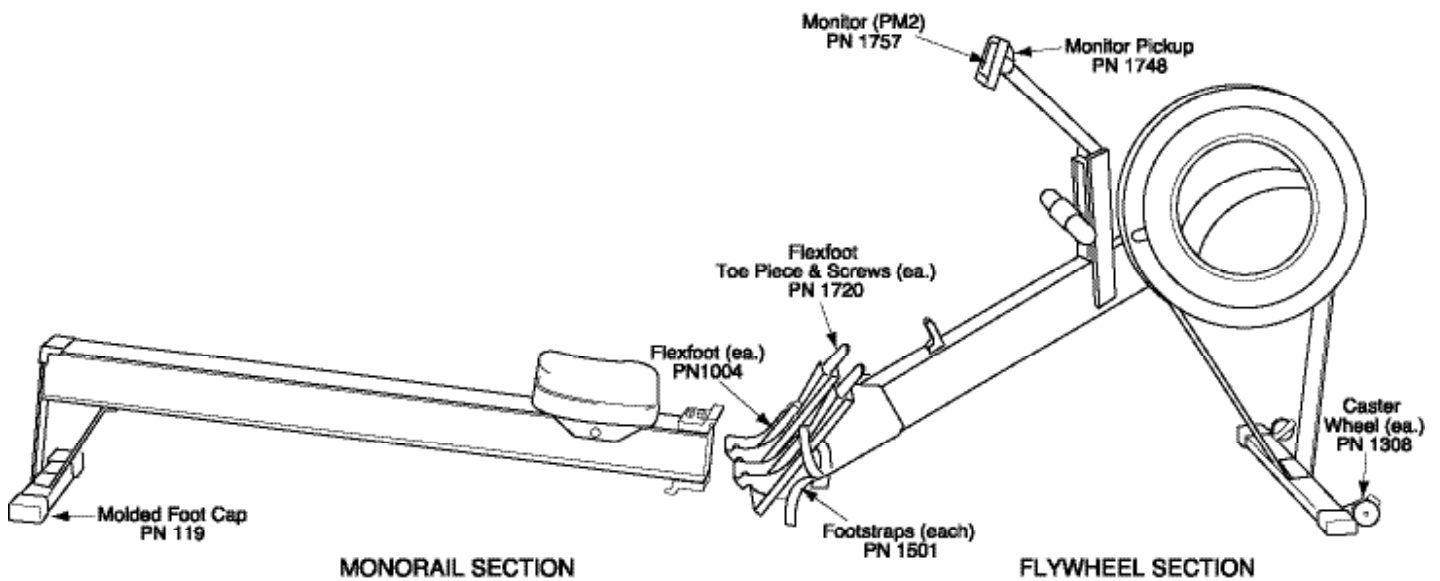
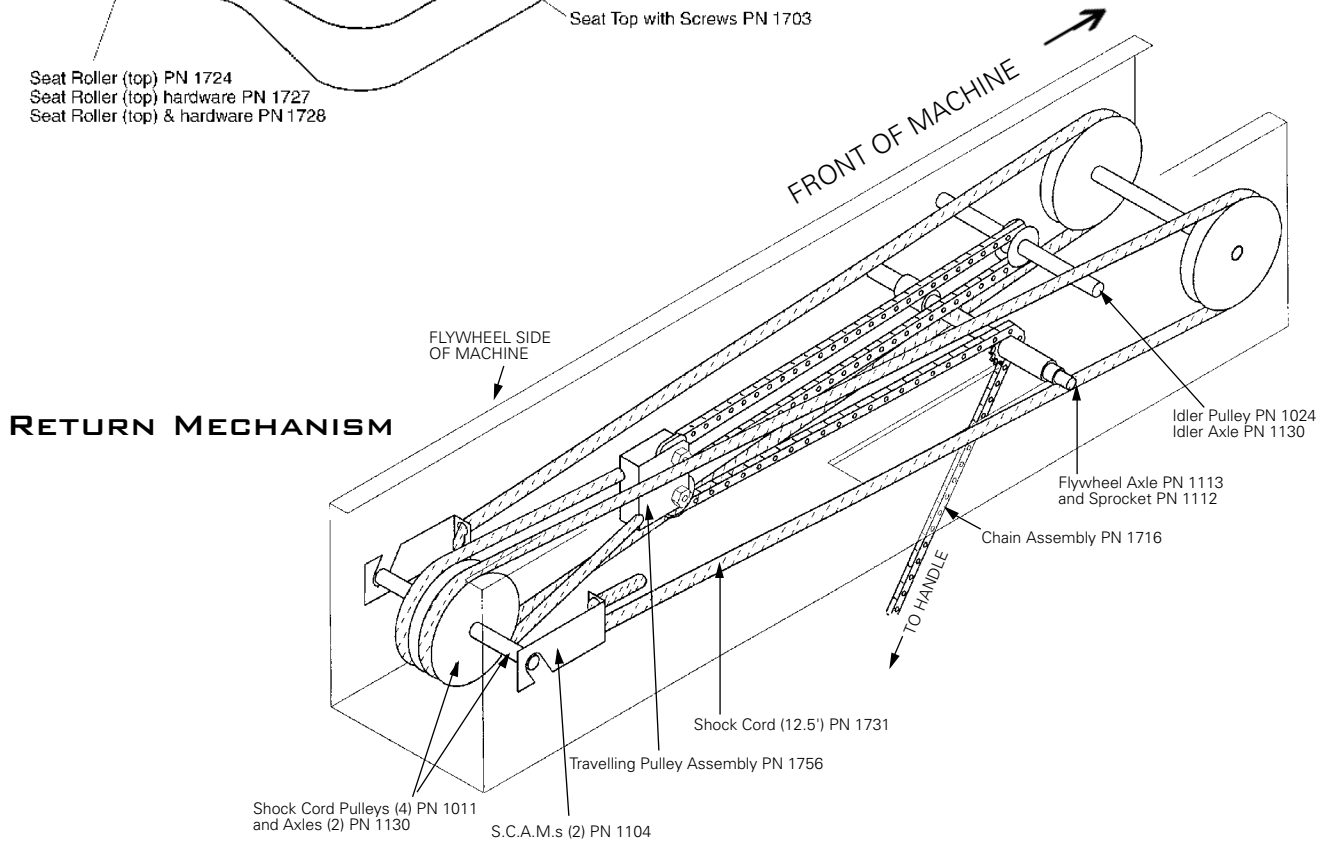
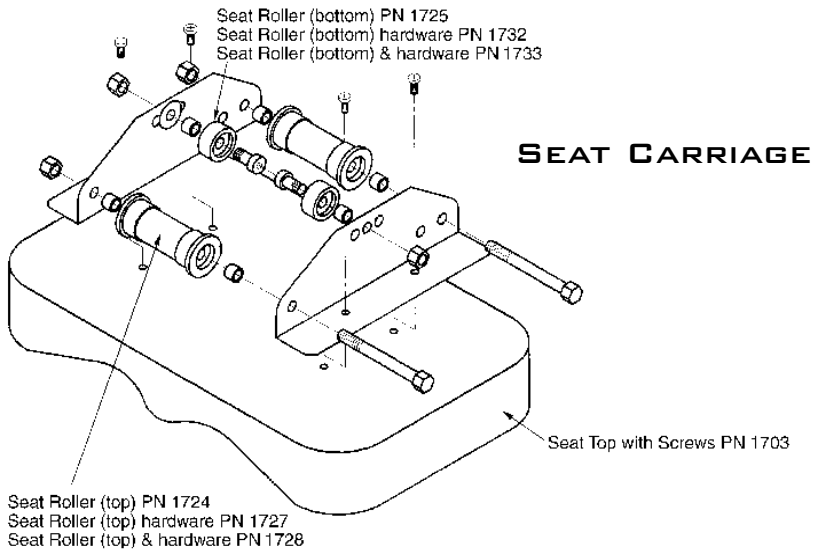

TABLE OF CONTENTS

Schematic Diagrams with Part Numbers	2
1 Unpacking and Assembly	3
2 Using the Indoor Rower	7
Safety	10
Before Your First Row	11
Technique	12
Workout Intensity	13
3 PM2 and Heart Rate	
Using the Performance Monitor (PM2)	14
Heart Rate Interface Installation–Model C.....	20
Using the Heart Rate Interface.....	21
4 Training on the Concept2 Indoor Rower	24
Training Logs	25
Pace Chart	28
5 Maintenance Procedures	
Recommended Schedule	29
Cleaning Monorail Top	30
Lubricating Chain.....	30
Removing and Installing the Return Mechanism Cover	31
Shock Cord Adjustment.....	32
Flywheel Opening and Cleaning.....	34
Performance Monitor Battery Removal/Replacement.....	35
Performance Monitor Arm Tension Adjustment.....	35
6 Troubleshooting	36



SCHEMATIC DIAGRAMS WITH PART NUMBERS



UNPACKING YOUR CONCEPT2 INDOOR ROWER



1

You should find the following parts in your Indoor Rower shipping box. If any parts are missing, please call us toll-free at 1.800.245.5676.

UNPACKING & ASSEMBLY



1.

CONTENTS OF PARTS BAG (PN 1752)



2.

ASSEMBLY OF FRONT LEGS

Tool Needed:

Aller
(pro)



Parts Needed:

4 washers

4 screws

(actual size)

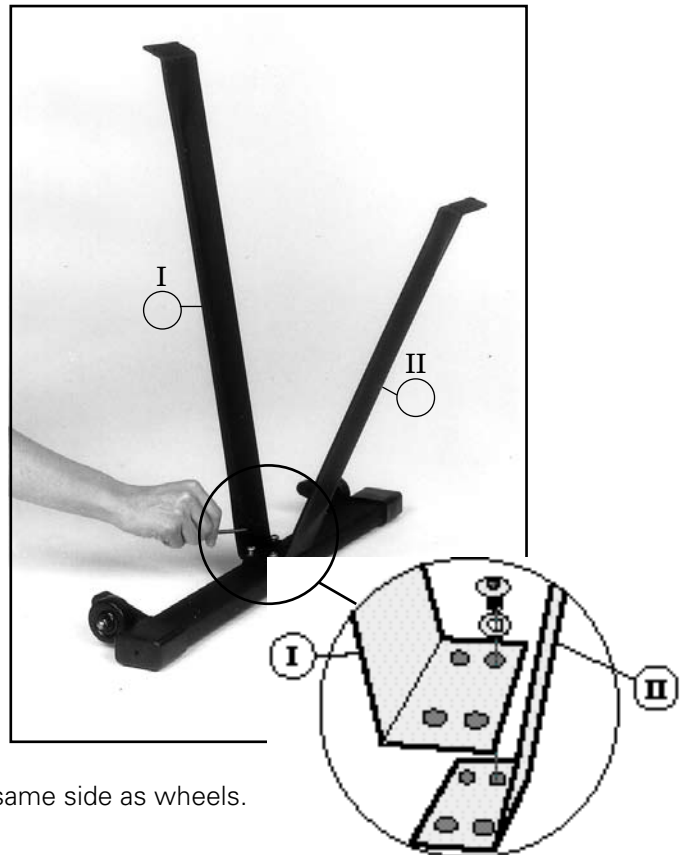
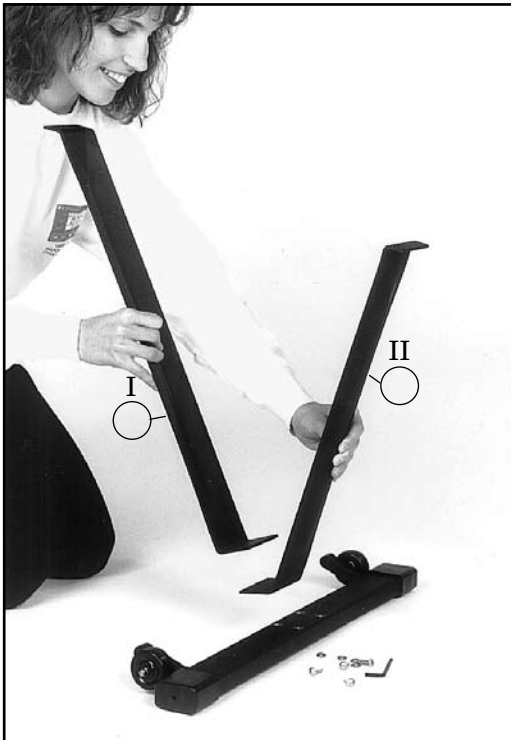
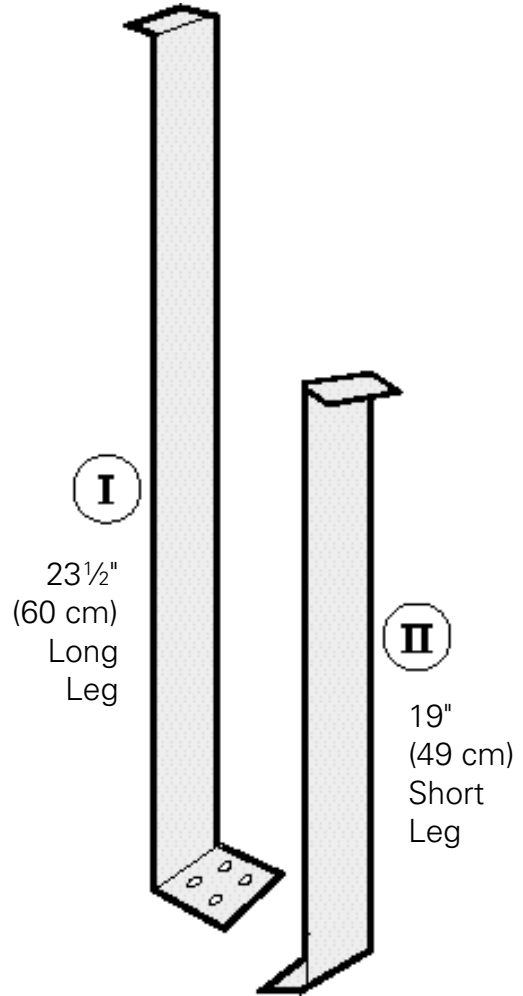
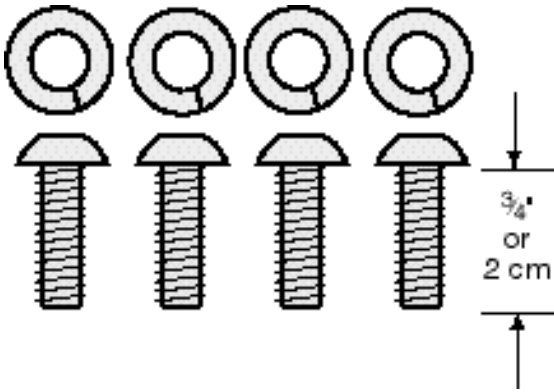

Note that longer leg (I) attaches to same side as wheels.

ATTACHING FRONT LEG

Tool Needed:
Allen Wrench
(provided)

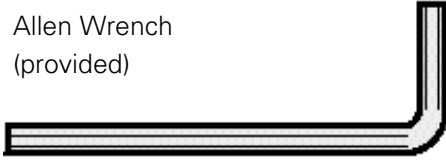

Parts Needed:
4 washers
4 screws
(actual size)

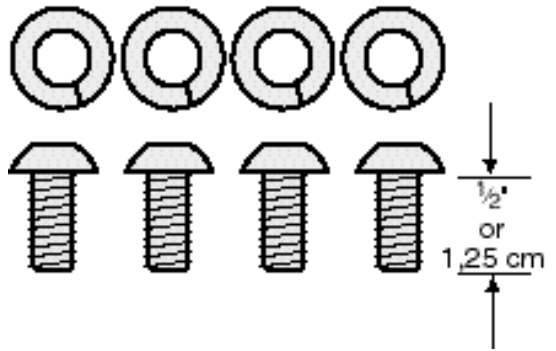

Front Leg Assembly

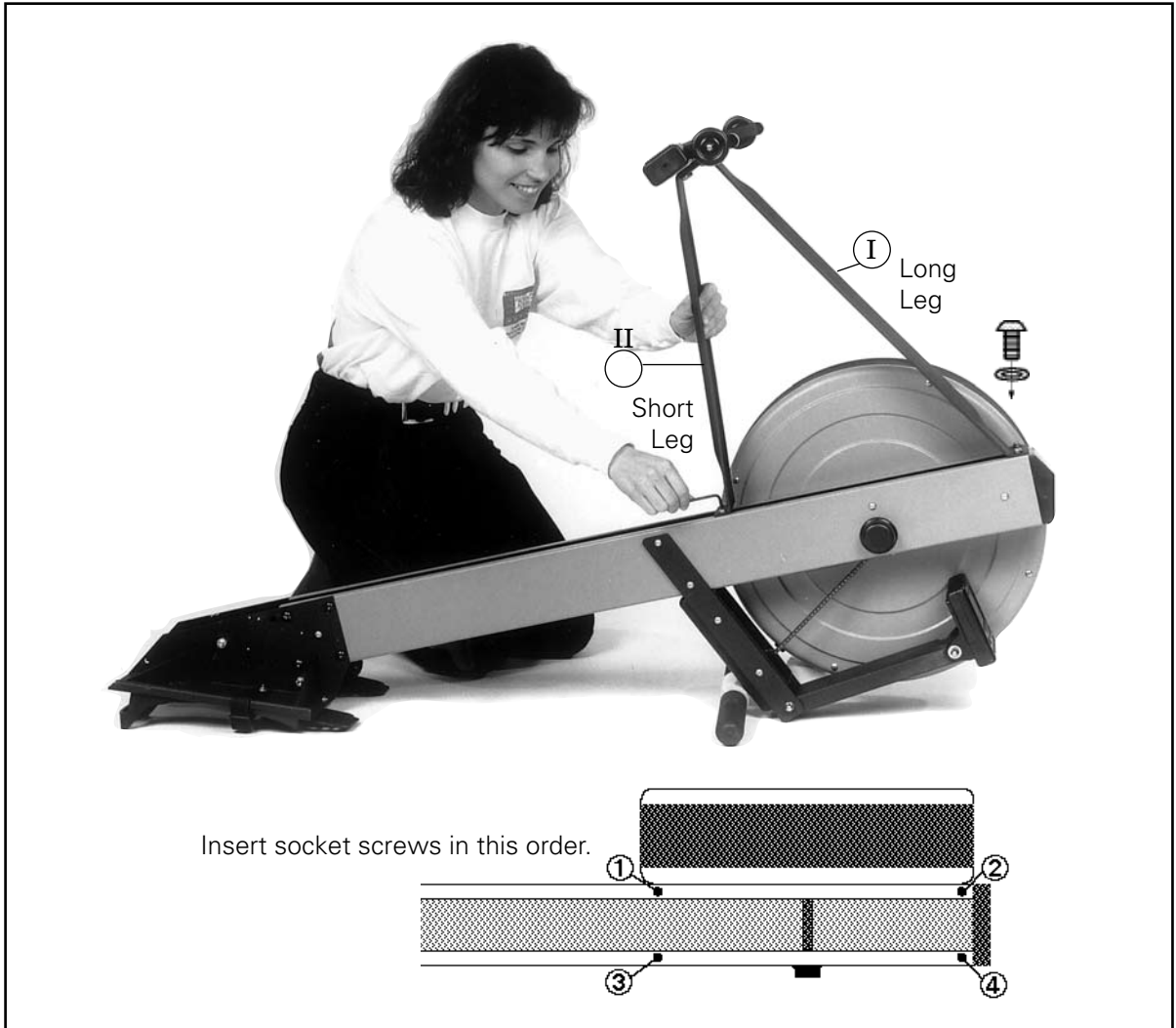

Please note direction of wheels.

CORRECT Leg Assembly

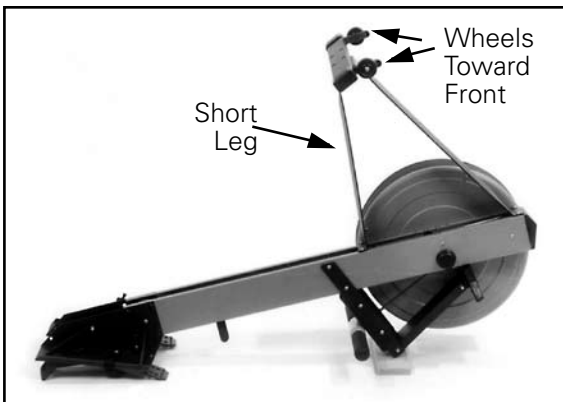

INCORRECT Leg Assembly

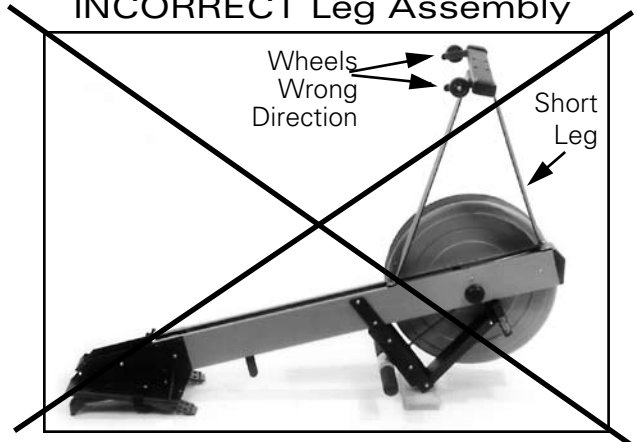

INSTALLATION OF FRAMELOCK

Tool Needed:
Allen Wrench
(provided)

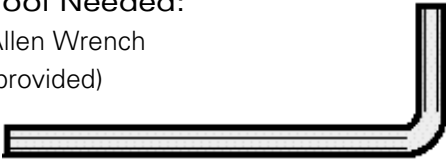

Parts needed:

2 washers
2 screws
(actual size)

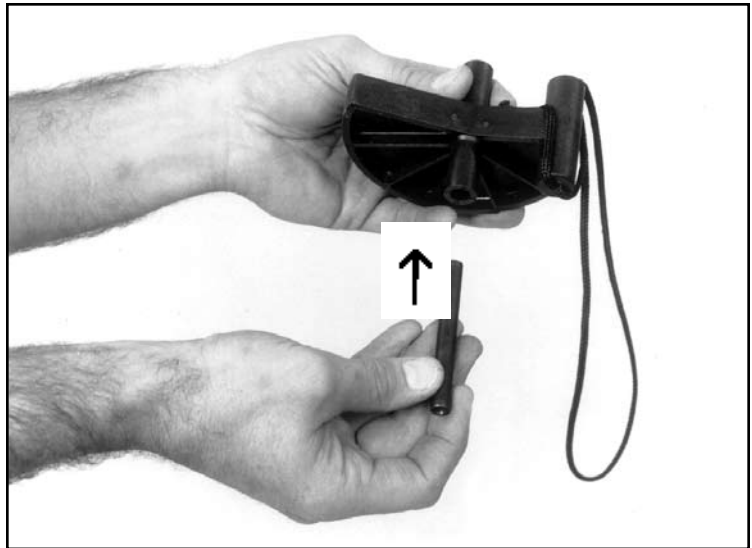
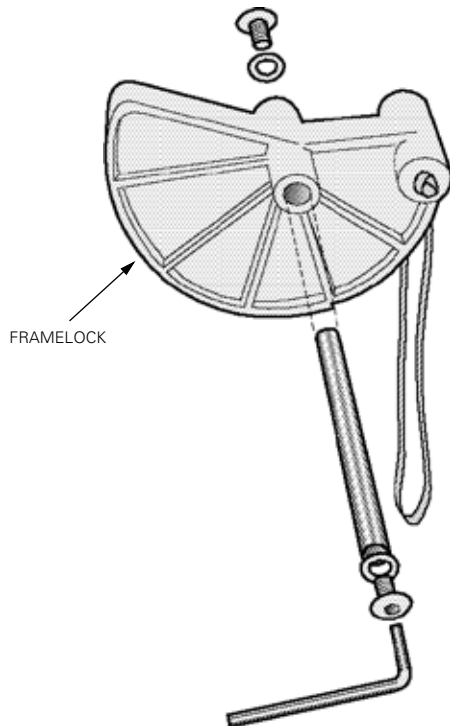
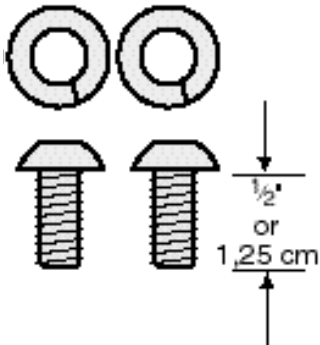

Insert axle through axle tube on frame lock.

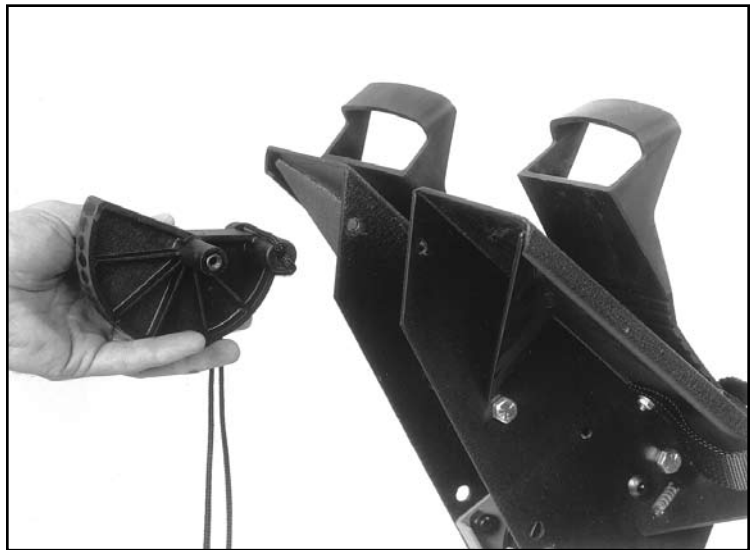

Place frame lock between footplates on Indoor Rower. The two footplates may need to be pulled apart slightly for the axle tube to fit. Be sure to line up axle tube to orient frame lock as shown.



Insert 1/2" screw and washer into each end of frame lock axle tube, through holes in footplates. Tighten with allen wrench.

USING THE INDOOR ROWER

ATTACHING THE MONORAIL

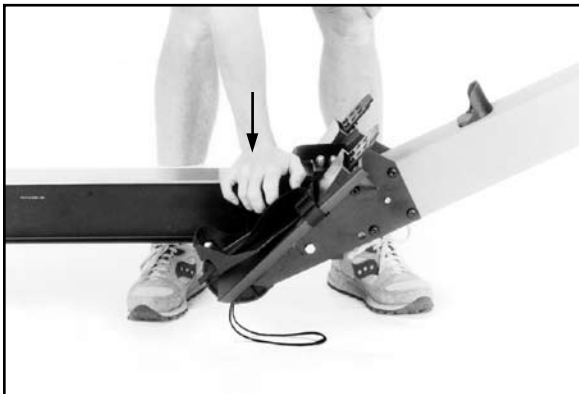
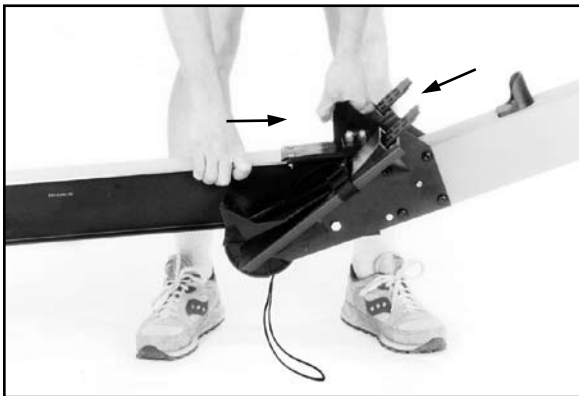
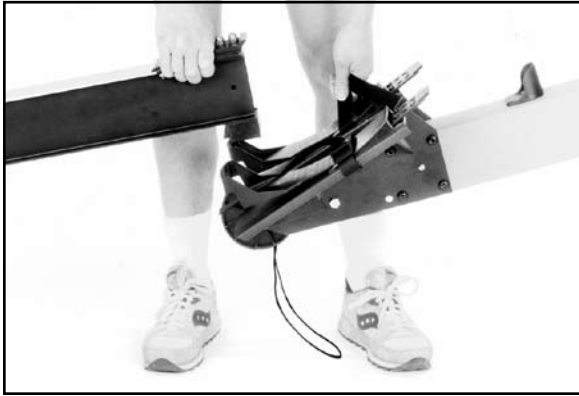

Place the flywheel and monorail sections of the Indoor Rower end to end.

Step 1. Using one of the footstraps as a handle, lift the footboard end of the flywheel section until it rolls on the caster wheels. Lift the end of the monorail to the same level.

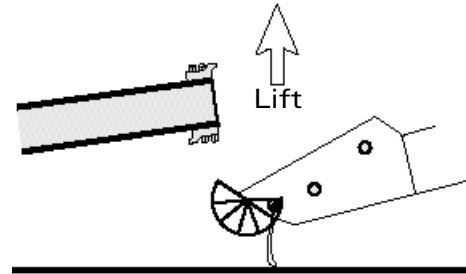

1.

Step 2. Bring the flywheel and monorail sections together between the footplates. The top hanger should be over the top bolt tube and the bottom hanger should hook over the bottom bolt tube.

Step 3. Lower both pieces until they connect securely and push down into place.

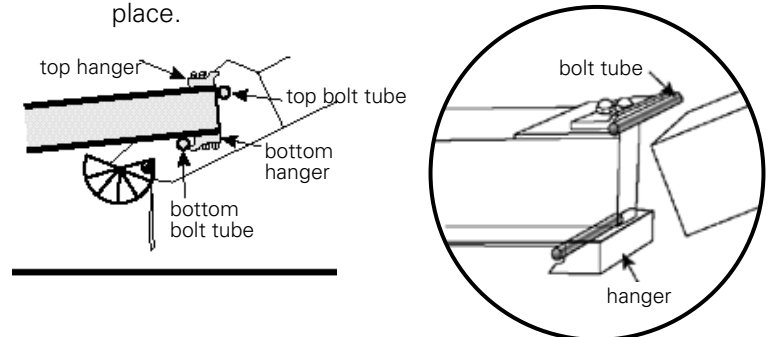

2.

Step 4. Rotate the frame lock around and push it into the locked position.

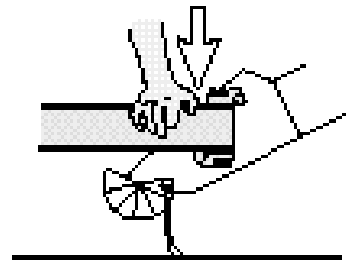

3.

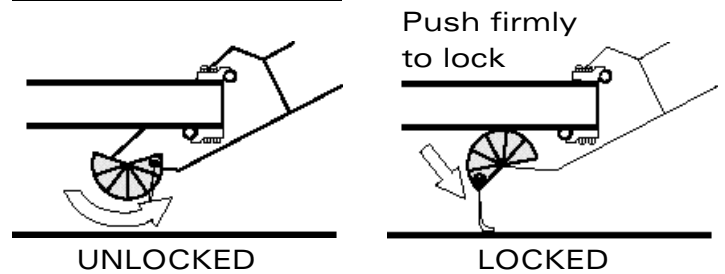

4.

2

USING THE INDOOR ROWER

CAUTION:

- Always have the frame lock in the locked position when the flywheel and monorail sections are connected. Failure to do so may result in injury if the unit is lifted or moved.
- To avoid possible injury, use caution while attaching the monorail section to the flywheel section and while operating the frame lock.

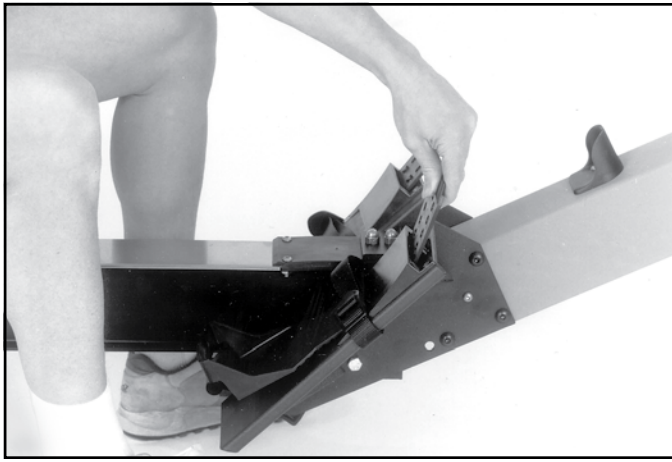

SETTING THE FLEXFOOT

To set the Flexfoot, pull the toe piece toward you to release the footpiece from the two pegs. Slide the toe piece up or down to achieve the proper setting, then press the toe piece back down onto the pegs.

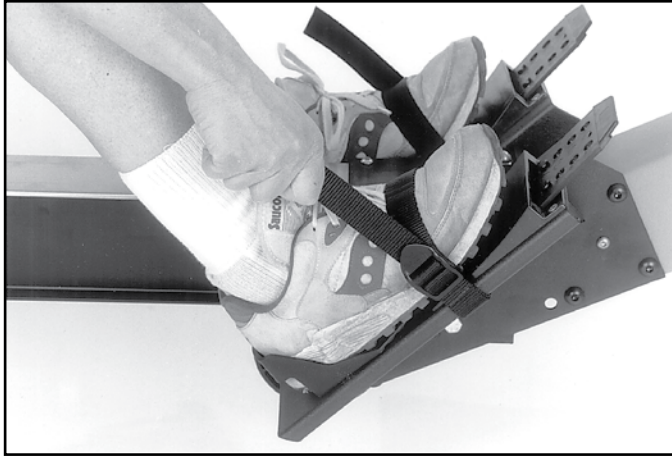

Begin by setting the Flexfoot heel so the strap crosses the ball of your foot. As you gain familiarity with the Indoor Rower, you may choose to raise or lower the Flexfoot a notch for reasons of flexibility or general comfort.



Optimal setting permits the knee, lower leg and ankle to be perpendicular to the floor at the catch.

Lowering the Flexfoot heel permits more seat travel.

Raising the Flexfoot heel cuts down on leg flexion.



USING THE HANDLE HOOK

Place the handle in the handle hook to make it easier to reach when you are seated on the rower. NOTE: It is best to let the handle rest against the fan cage (as shown at left) rather than in the handle hook when the machine is not in constant use (i.e. overnight, between workouts). This will prolong the life of the shock cord.

ADJUSTING THE PERFORMANCE MONITOR

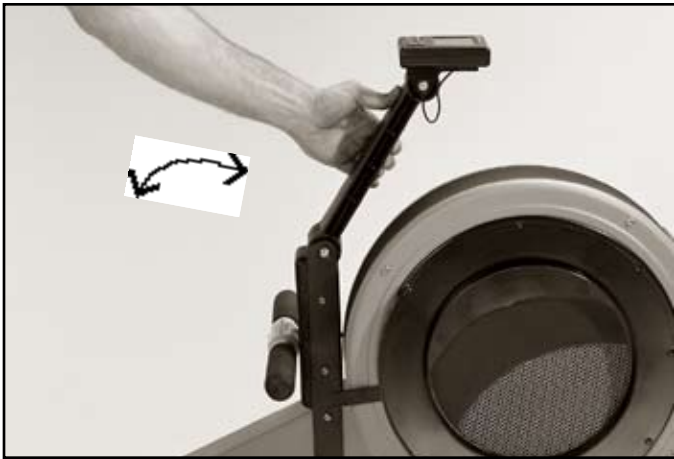
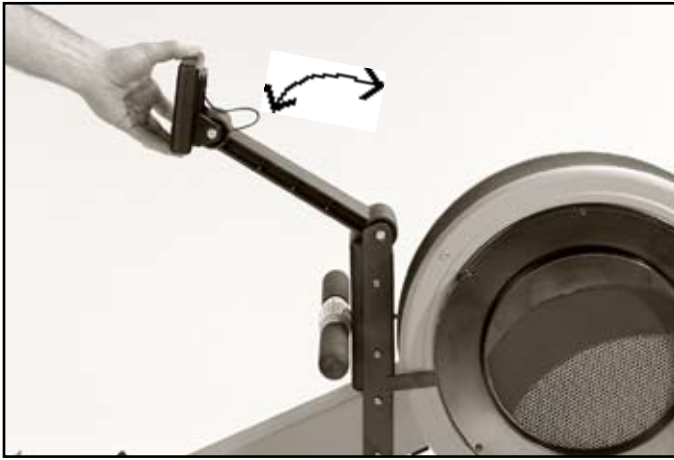

SEAT PAD

Seat comfort varies from one individual to another. If you do not find the standard seat to be completely comfortable, you may wish to try the seat pad which is available from Concept2.

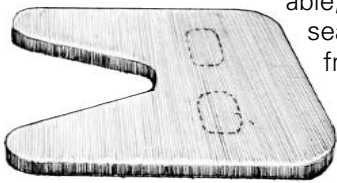

Order PN 1409.

STORAGE

The two parts may be placed upright as shown here for more compact storage.



CAUTION:

Care should be taken when standing the flywheel section up as the balance may shift suddenly.

DETACHING THE MONORAIL

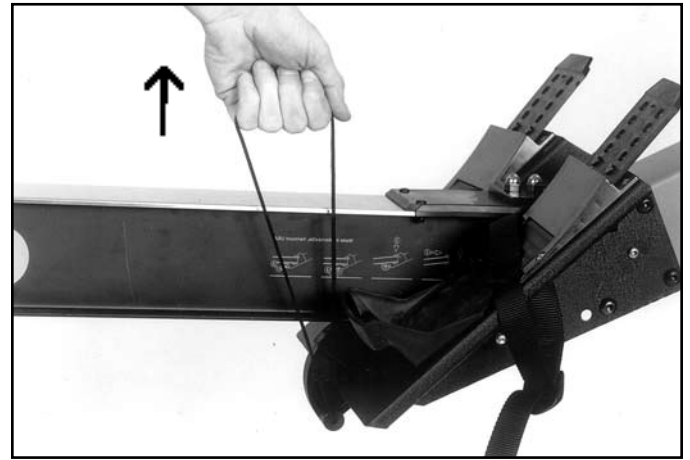

1. Release the frame lock from the locked position by pulling up on the rope, allowing the frame lock to rotate into unlocked position.

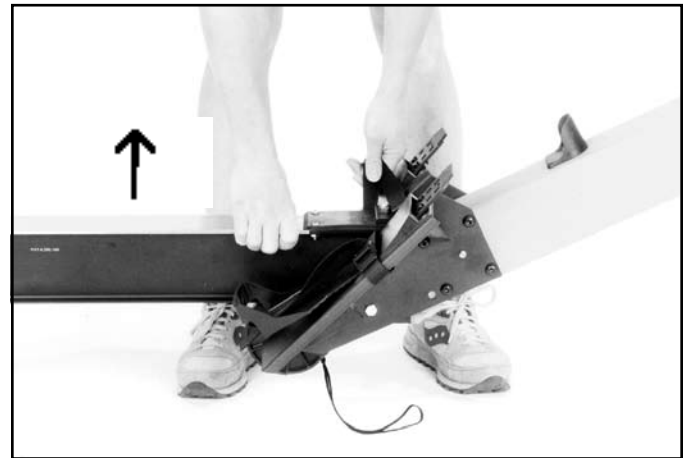

2. Lift the footstrap slightly with one hand to disengage the monorail.

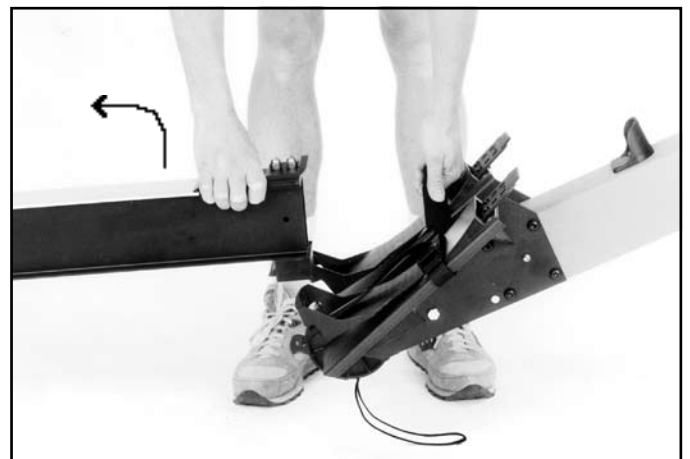

3. Remove monorail with the other hand.

SAFETY



Do not let handle fly into chain guide.



Pull straight back with both hands.

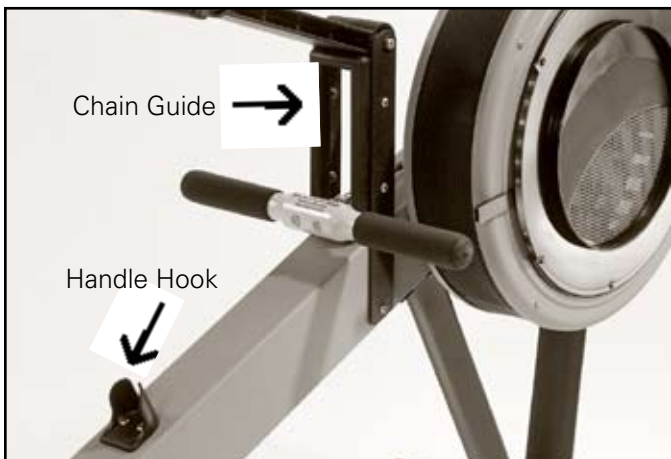

Place handle against the chain guide or in handle hook before letting go.



Never twist chain or pull from side to side.

CAUTION

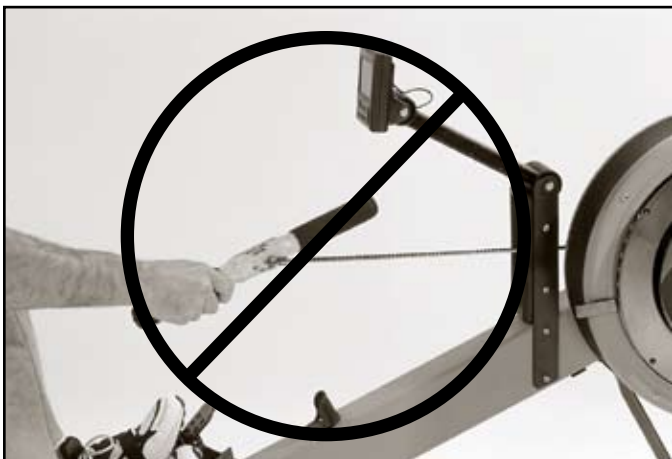

Do not row with one hand only.
Abuse of the chain can result in injury.



Keep clothing free of seat rollers.

CAUTION



Keep children, pets, and fingers away from seat rollers. Seat rollers can cause injury.

Chain **does not** require oiling prior to first use.



Perform proper maintenance as described in the Maintenance section of this manual (page 29).

CAUTION

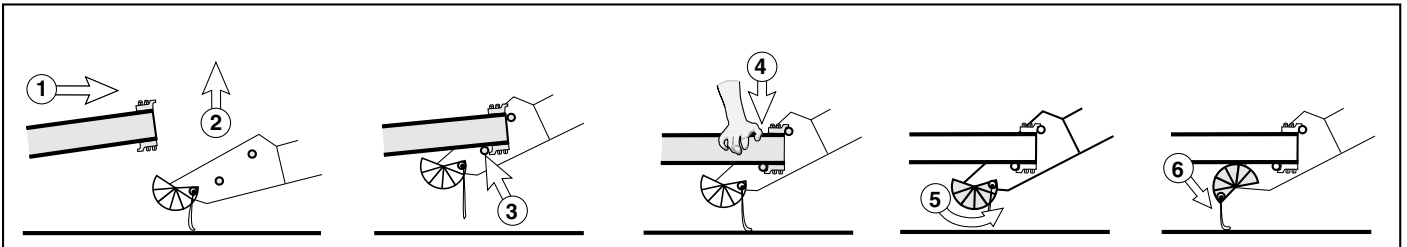

ALWAYS PUT THE FRAMELOCK IN THE LOCKED POSITION (see page 7) BEFORE MOVING THE INDOOR ROWER.

IMPORTANT SAFETY NOTES:

- Use of this machine with a worn or weakened part, such as the chain, sprocket, swivel connector, handle U-bolt, or shock cord, may result in injury to the user. When in doubt about the condition of any part, Concept2 strongly advises that it be replaced immediately with genuine Concept2 parts.
- To avoid possible injury, use caution while attaching the monorail section to the flywheel section and while operating the frame lock.

BEFORE YOUR FIRST ROW

- 1) Consult your physician. Be sure that it is not dangerous for you to undertake a strenuous exercise program.
- 2) Carefully review the rowing technique information on page 12. Improper technique such as extreme layback or jumping off the seat can result in injury.
- 3) Start each workout with several minutes of easy rowing for a warm-up.
- 4) Start your exercise program gradually.
Row no more than 5 minutes the first day to let your body adjust to the new exercise.
- 5) Gradually increase your rowing time and intensity over the first two weeks.
Do not row at full power until you are comfortable with the technique and have rowed for at least a week. Like any physical activity, if you increase the volume and intensity too rapidly, fail to warm up properly, or use poor technique, you will increase the risk of injury.
- 6) Rowing with the damper setting too high can be detrimental to your training program by reducing your output and increasing risk of injury. It is better to err on the light side rather than on the heavy side.

PROPER ROWING TECHNIQUE

- Have someone watch you to help you match your body positions to those shown below.
- These positions should be blended together to make a smooth and continuous stroke with no stopping at any point in the stroke.
- Aim for a stroke rate of between 24 and 30 strokes per minute as displayed on the Performance Monitor.
- Grip should be loose and comfortable; wrists should be level.



The catch

- Extend your arms straight toward the fly-wheel
- Keep wrists flat
- Lean your upper body slightly forward with back straight but not stiff
- Slide forward on the seat until your shins are vertical (or as close to this as your flexibility will allow)

The drive

- Begin the drive by pressing down your legs
- Keep your arms straight and hold your back firm to transfer your leg power up to the handle
- Gradually bend your arms and swing back with your upper body, prying against the legs until you reach a slight backward lean at the finish

The finish

- Pull handle all the way into your abdomen
- Straighten your legs
- Lean your upper body back slightly

The recovery

- Extend your arms toward the flywheel
- Lean your upper body forward at the hips to follow the arms
- Gradually bend legs to slide forward on the seat

The catch

- Draw your body forward until the shins are vertical
- Upper body should be leaning forward at the hips
- Arms should be fully extended
- You are ready to take the next stroke

WORKOUT INTENSITY

The intensity of your workout is not determined by the setting of the damper but by your own effort. The faster the wheel spins, the more resistance you will feel, regardless of the setting you choose. This is because the fan blades on the flywheel create wind resistance to slow the flywheel down.



WHAT IS A ROWING WORKOUT?

Intensity, Duration, Resistance

A rowing workout can be tailored to achieve a variety of results by adjusting intensity and duration. Here are some suggestions to get you started. For specific workout suggestions to achieve your goals, please refer to the Training section on page 24.

- ➡ **Do not row too hard.** Row with an intensity that will allow you to keep going for at least 20 minutes. This will enable you to take full advantage of the cardiovascular benefits of rowing.
- ➡ **Control the intensity of your rowing by how hard you pull.** Think of the Indoor Rower as your boat. If you row easily, you can row for a long time. To make the boat go faster, you pull harder. If you try to make the boat go very fast you will be exhausted in a short time. Air resistance on the flywheel fan works just like the water resistance on a boat.
- ➡ **Watch the center display of the Performance Monitor.** This indicates your power output, or how fast your “boat” is going, stroke by stroke. It gives you immediate feedback on how hard you are pulling.
- ➡ **Set the damper to make the Indoor Rower feel like a sleek, fast boat (numbers 1–4) or a big, slow rowboat (numbers 6–10).** Either “boat” can be rowed hard or easily. As you try to make either boat go fast, you will need to apply more force. Making the sleek boat go fast requires you to apply your power more quickly. When trying to make the big boat go fast, you will feel the greatest force. Rowing in a setting that results in too high a force can be detrimental to your training program by reducing your output, your enjoyment, and the duration of your workouts. As with any exercise, rowing with too high a force increases the risk of injury.

SPEED SETTINGS ON THE FLYWHEEL



UP FOR SLOWER



DOWN FOR FASTER

USING THE PERFORMANCE MONITOR 2 (PM2)

OVERVIEW OF THE PM2 OPERATION

Your Concept2 Indoor Rower is equipped with a PM2, the second generation of our electronic Performance Monitor. We have designed the PM2 to be as friendly as possible while making several powerful new functions available to you.

There are three levels of operation:

- LEVEL I Automatic operation:** Like the original PM, the PM2 has an automatic mode which will monitor your workout without requiring you to use any buttons at all. You will also find it very easy to use the DISPLAY button to change the output units displayed. (See page 15.)
- LEVEL II Preset Workouts and Recall:** To introduce more variety into your exercise program, you can set up 4 different kinds of workouts on the PM2: preset time duration, preset distance, timed intervals, and distance intervals. After you have finished a workout, you can use RECALL to view your performance. All Level II functions have labeled buttons. (See pages 16.)
- LEVEL III Extra Functions:** Advanced users can take advantage of these extra functions: two odometers (resettable and non-resettable), splits to be measured and displayed during your workout at an interval of your choice; drag factor display; and PM2 self-test. Extra functions are activated using button combinations which are described on page 19.



LEVEL I. AUTOMATIC OPERATION

A. GETTING STARTED

All you need to do is get on and row. The PM2 will automatically come on and begin to display information about your performance. Here is what the displays are showing:

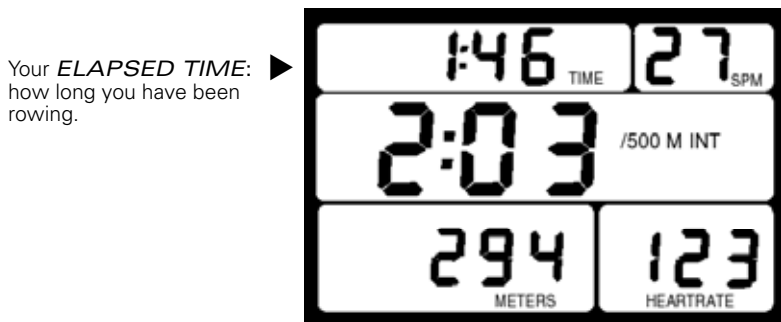

Your **ELAPSED TIME**: how long you have been rowing.

Your **STROKE RATE** or cadence in Strokes per Minute (**SPM**), updated every stroke. Aim for somewhere between 20 and 30 spm.

Your **OUTPUT FOR EACH STROKE** how hard you pulled on the last stroke. This is displayed in a choice of 3 units:

PACE/500METERS: how long it would take you to row 500 meters if you kept rowing at that same pace. The smaller the number, the faster you are going.

CALORIES/HOUR: the rate at which you were burning calories during the last stroke. It displays the approximate number of calories you would burn in an hour if you kept rowing at that pace. The larger the number, the faster you are going.

WATTS: the power you exerted during the last stroke, in watts. The larger the number, the faster you are going.

Your **TOTAL OR CUMULATIVE OUTPUT** since you started rowing. This is displayed in a choice of 4 units:

AVERAGE PACE what your average pace per 500 meters has been since you started.

METERS: the number of meters you have rowed since you started.

CALORIES: the approximate number of calories you have burned since you started.

WATTS: your average power out-put in watts since you started.

If you have the **OPTIONAL HEART RATE** interface* attached and are wearing a chest belt, this display will show your heart rate in beats per minute.

*For more information, see pages 20-23. To order your Heart Rate Interface, call Concept2 toll free at 1-800-245-5676



PM2 & HEARTRATE

B. DISPLAY OPTIONS

Now try pressing the DISPLAY button: Each time you press it, the display changes, cycling through the choices shown at right.

- You can choose any of these displays to watch while you row.
- You can change the display any time during your workout.

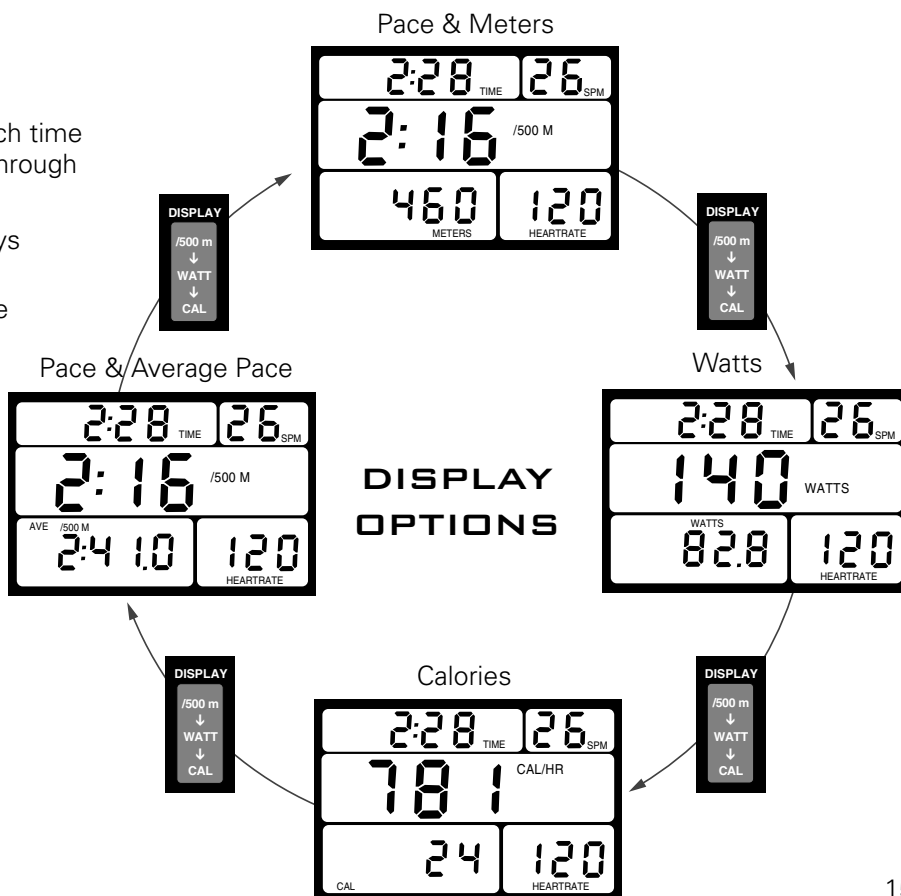

A WORD ABOUT CALORIES:

Due to the differences in body weight and efficiency, calories on the PM2 are only an approximation of calories burned by the person rowing. The formula used in the PM2 is as follows:

Calories = (4x ave. watts/1.1639)+300 cal/hour x time rowed (in hours).

This formula assumes a person of 175 pounds (80 kg.) and a base rate of 300 cal/hour to move your body through the rowing motion at 30 strokes/minute.

LEVEL II. PRESET WORKOUTS & RECALL

A. SETTING UP WORKOUTS

It is easy to set up a variety of workouts on your PM2. Specifically, you can set up:

- a single work session of preset time duration
- a timed interval workout (alternating work time and rest time)
- a single work session of preset distance
- a distance interval workout (alternating work distance and rest time)

All of these types of workouts can be set up using these buttons:

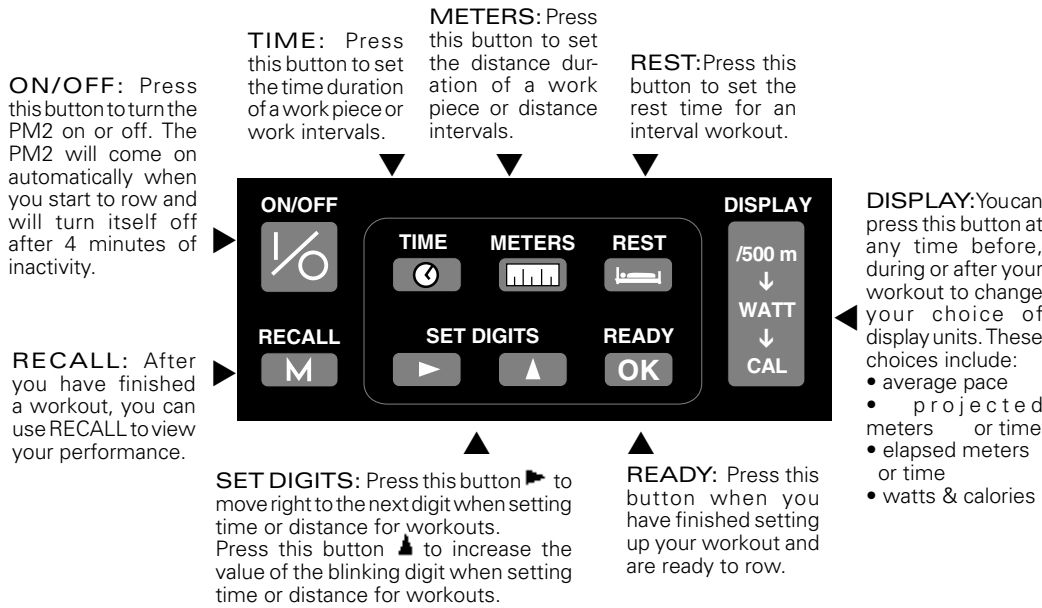

Projected Finish Display: when you are rowing one of these pre-set workouts, you will have an additional display option in the lower left field: Projected Finish Time or Distance. If you are rowing a preset distance, this display will show you your projected finish time if you keep up your present pace. If you are rowing a preset time, this display will show your projected finish distance if you keep up your present pace. To see Projected Finish, simply press the DISPLAY button to cycle through the options until the word "PROJ" is displayed above the time or distance.

B. SAMPLE WORKOUTS:

The **sample workouts** on these two pages are designed to help you become familiar with this capability of your PM2. We encourage you to set them up on your own PM2 as you read through the instructions. They are also good workouts to try once you have learned proper rowing technique and built up your time rowing on the Indoor Rower.

Example #1:
PRESET TIME
45 minute row

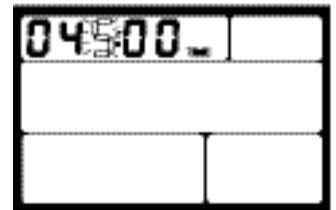
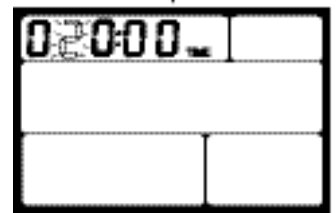
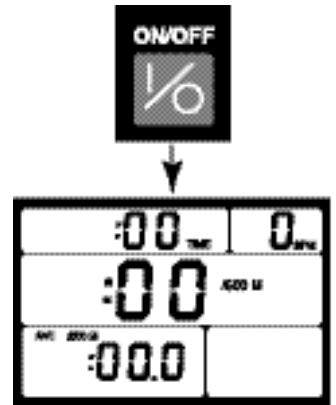

Example #2:
PRESET DISTANCE
5000 meter row

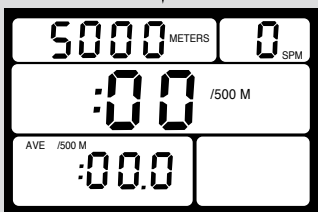
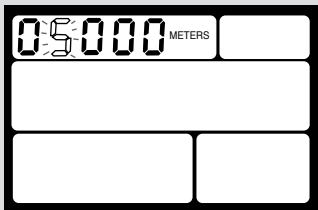
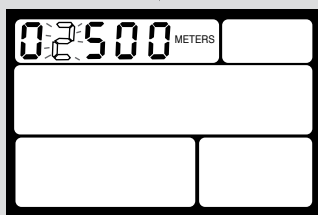
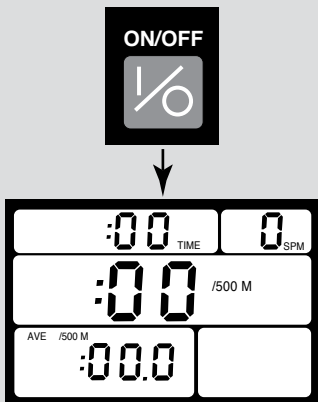

Example #3:
TIME INTERVALS
10 x 1 minute hard/
1 minute easy

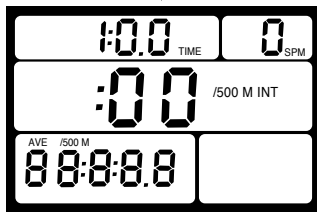
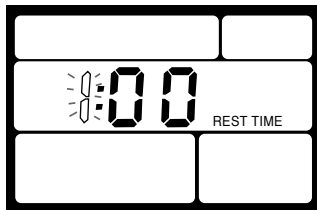
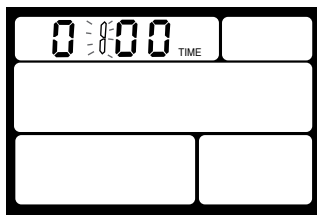
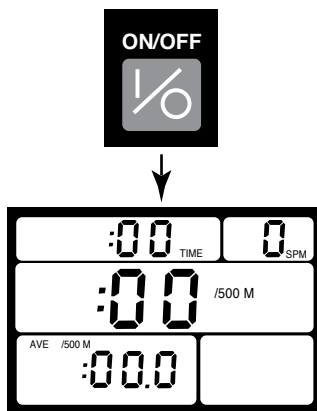

Example #4:
DISTANCE INTERVALS
5 x 500 meters
with 2 minutes rest

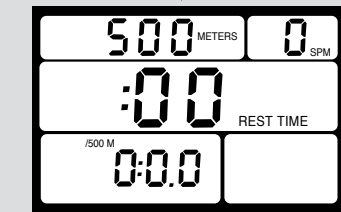
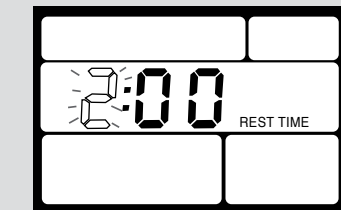
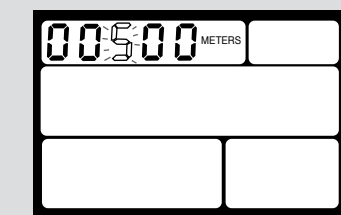
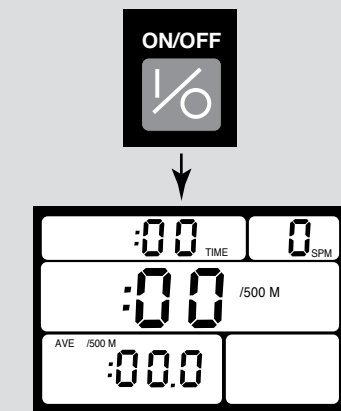

#3 & #4: The interval number will be displayed in the upper right corner during the rest interval.

You are now ready to row. You may change display now, during or after your workout.



C. USING RECALL

After you have finished a workout, you can use RECALL to view your performance during each split or interval of your workout.





The first press of the RECALL button displays the end of workout information for your workout. Each successive press of the RECALL button shows the next earlier split or interval until either the last split has been displayed or there is no more memory available (maximum storage is 20 splits or intervals). The word "SPLIT" will appear on the screen to indicate that you are viewing split information as opposed to end of workout information. Default splits are: 2 minutes for timed workouts and 500 meters for distance workouts. See next section to set custom splits.

NOTE: Your workout results will remain in the PM2 memory until another workout is started, even if the PM2 is turned off.

TIPS:

- The  button works the same as RECALL. It shows the next earlier split or interval.
- The  button shows the next later split or interval.
- The DISPLAY button can be used during split recall to view splits in various units.
- Pressing REST during split recall shows splits in cumulative mode. This is indicated to the user by "CU" in the center display field. Press REST again to exit CU mode.
- HEART RATE box shows your HR at the end of that interval or split
- SPM box shows your average strokes per minute for the interval or split.

RECALL DISPLAY CHART

Type of Workout	Splits Taken	Recall Display
automatic count up mode	every 2 minutes (or custom split interval if set)	
preset timed workout	every 2 minutes (or custom split interval if set)	
preset distance workout	every 500 meters (or custom split interval if set)	
preset timed intervals	at end of each time interval	
preset distance intervals	at end of each distance interval	

LEVEL III. EXTRA FUNCTIONS (FOR ADVANCED USERS)

All of the PM2 buttons except the ON/OFF button have extra functions which are activated when you press and hold down the READY button.

These special functions include:

- **Two Odometers:** one is resettable (trip odometer) and one is not resettable
- **Split Intervals:** you can set the PM2 to measure splits at intervals which you set. Each split will be saved for recall after you finish and can be displayed for 6 seconds while you row.
- **Drag Factor:** you can set the PM2 to display the drag factor which it calculates during the rundown of the flywheel.
- **PM2 Display Test**

BUTTON SEQUENCES & DESCRIPTIONS OF EXTRA FUNCTIONS:

SPLITS

Custom Splits (time)

Hold down then press

to set a time interval for split measurement. Use the SET DIGITS buttons to set the split time. Then press READY when done. Note: your custom split interval will not be retained through a power down. Default value is 2 minutes.

Custom Splits (distance)

Hold down then press

to set a distance interval for split measurement. Use the SET DIGITS buttons to set the split distance. Then press READY when done. Note: your custom split interval will not be retained through a power down. Default value is 500 meters.

DRAG FACTOR

Hold down then press

to have a drag factor displayed in the lower right display window. Repeating this button sequence will turn off the drag factor display. The drag factor is most helpful if you row on Concept2's in different locations and want to be sure the resistance setting is the same. Check the drag factor on your "home" machine, and then adjust the damper on the "away" machine until you get the same drag factor. Typical range for drag factor on the Indoor Rower is: 103 (damper setting 1)-223 (damper setting 10). When PM2 powers up or resets, the drag factor display will be off by default.
 Note: When a heart rate monitor is being worn, HR will override the drag factor and will always be displayed.

The diagram shows a central control panel with the following buttons: ON/OFF (1/0), RECALL (M), TIME (clock icon), SET DIGITS (play icon), METERS (bar chart icon), REST (bed icon), READY (OK), DISPLAY (vertical menu with /500 m, WATT, CAL), and a vertical scroll bar.

Splits On/Off

Hold down then press

to have splits displayed during your workout. Repeating this button sequence will turn off the split display during your workout. When the PM2 powers up, splits are off by default.

PM2 DISPLAY TEST

Hold down then press

to perform a self-test including all segments test. Press ON/OFF to end the test.

TWO ODOMETERS

Not Resettable

Hold down then press

to display cumulative distance rowed. This odometer is not resettable. Distance is in kilometers and is only displayed when READY and are being pressed.

Resettable

Hold down then press

to display a resettable record of distance rowed. At 99,999 it rolls over to 00,000. Press RECALL to reset to 0. Press READY or ON/OFF to get out of this function.

This equipment has been tested and found to comply with the limits for a Class B digital device, pursuant to Part 15 of the FCC rules. These limits are designed to provide reasonable protection against harmful interference in a residential installation. This equipment generates, uses and can radiate radio frequency energy and if not installed and used in accordance with the instructions, may cause harmful interference to radio communications. However, there is no guarantee that interference will not occur in a particular installation. If this equipment does cause harmful interference to radio or television reception, which can be determined by turning the equipment off and on, the user is encouraged to try to correct the interference by one or more of the following measures:

- Reorient or relocate the receiving antenna.
- Increase the separation between the equipment and the receiver.
- Connect the equipment into an outlet on a circuit different from that to which the receiver is connected.
- Consult the dealer or an experienced radio/TV technician for help.

THE OPTIONAL PM2 HEART RATE INTERFACE

Installing on Model C



PN 1761

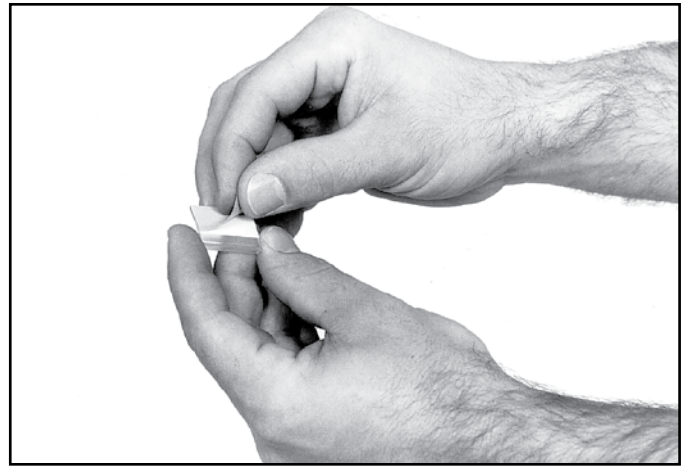

4.



1.

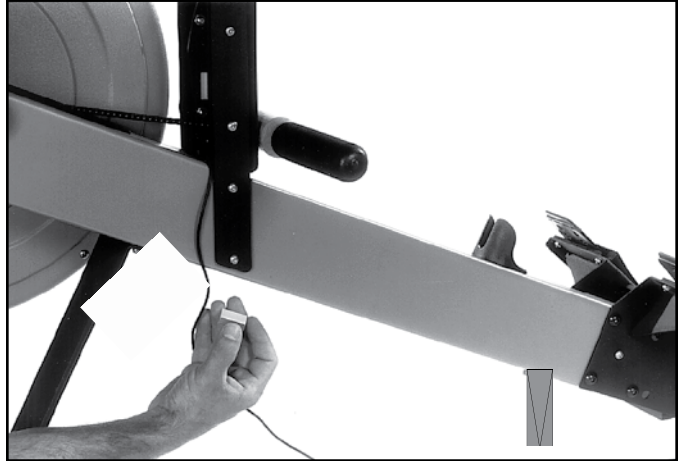

5.

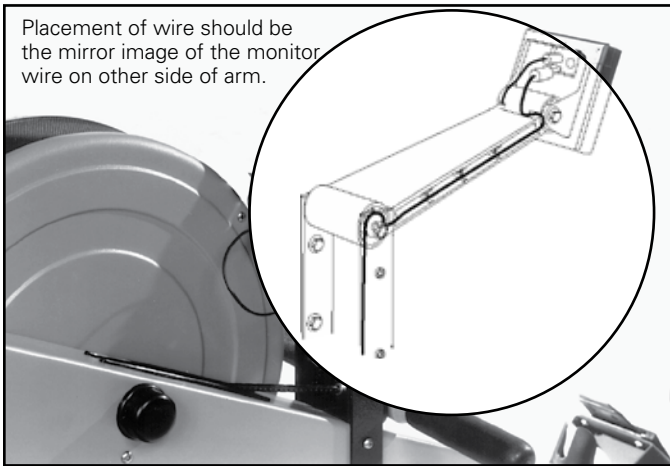

2.

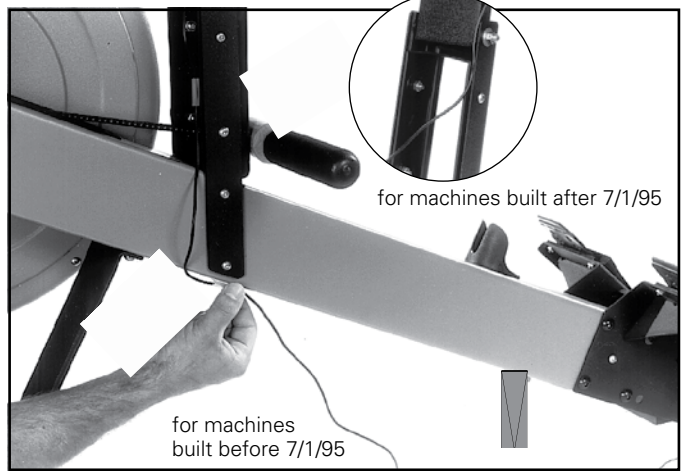

6.

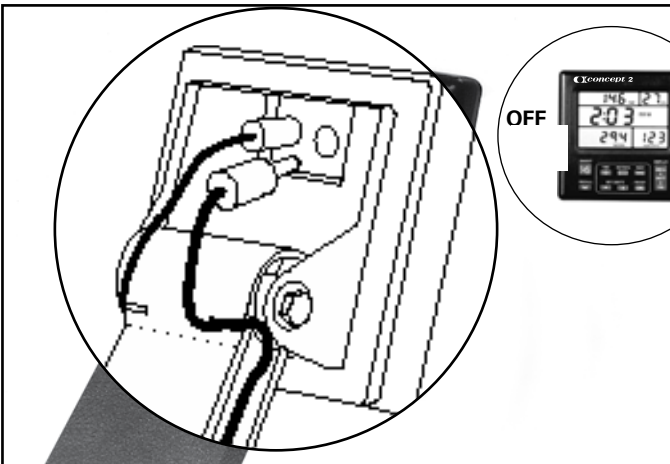

3.

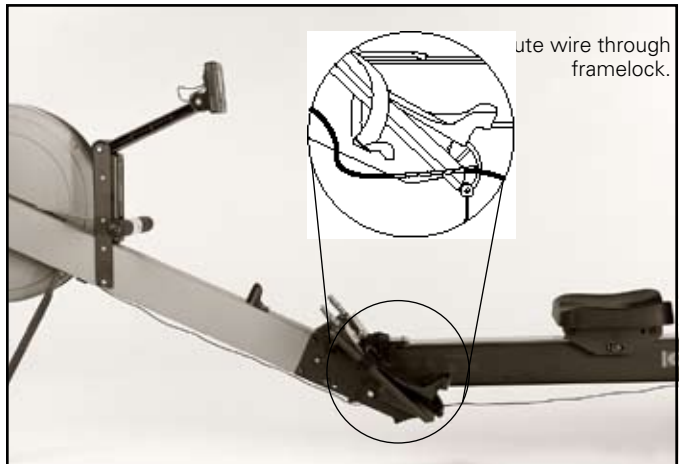

7.

HOW TO WEAR YOUR POLAR™ (OR POLAR COMPATIBLE) HEART RATE MONITOR

1. WET THE ELECTRODES

Wet the electrodes (the two grooved rectangular areas on the underside of the Belt Transmitter) thoroughly with water or saliva.

2. SECURE THE BELT TRANSMITTER

Center the Belt Transmitter flat against your skin, as high under the Pectoral Muscles (breasts) as is comfortable. The Belt Transmitter should fit snugly and comfortably and allow for normal breathing. If your Belt Transmitter is the snap-on type, position the red snap on the left side of the belt and snap in place on belt.

3. ROW!!

Your heart rate will be displayed in the lower right display in all PM2 display modes.

NOTE: It sometimes takes a few minutes of exercise to achieve a consistent Heart Rate signal.



Read
Heart Rate
here.

PRECAUTIONS

- Thoroughly wipe your Polar Belt Transmitter dry after each use.
- Do not store in a non-breathable or plastic bag where moisture may become trapped. Store in a warm dry place.
- Do not expose your HRM to direct sunlight, extreme heat above 50 degrees Celsius (122 degrees Fahrenheit) or extreme cold below -10 degrees Celsius (14 degrees Fahrenheit).
- Do not bend or stretch the electrode strips on your Belt Transmitter, especially when storing.

TROUBLESHOOTING

What if the heart rate reading is erratic or totally absent?

NOTE: Occasionally the Heart Rate Monitor will pick up bad data for a number of reasons. When the PM2 recognizes bad data, the display will go blank rather than show the bad data. It will take 5 seconds or longer to reestablish and display accurate readings.

1. Repeat the electrode wetting procedure. The electrodes must be wet to pick up accurate heart rate readings.
2. Make sure the transmitter is centered with electrodes flat against your skin, as high under the pectoral muscles as is comfortable.
3. Wash your belt transmitter with mild soap and water, if you have not been doing so regularly.
4. Make sure your Receiver is within the proper range to receive transmission (1 meter/3 feet from your chest belt).

5. Check the connection on the back of the PM2 where the receiver cable plugs in. Check the connection between the cable and the receiver.
6. If you are exercising within range of strong electromagnetic signals the heart rate readings may elevate to abnormal levels. Common sources of electromagnetic signals are televisions, computers, cars, TV antennas, high voltage power lines and motor driven exercise equipment.
7. Signals from more than one Belt Transmitter within the transmission range (1 meter/3 feet) may also cause incorrect readings. Check your surroundings and move away from the source of interference if possible.

NOTE: Two Indoor Rowers with Heart Rate hardware must be at least 4 feet (1.22 meters) apart to avoid interference.

If further troubleshooting assistance is needed, call Concept2 at 800.245.5676.

MONITORING HEART RATE TO DETERMINE TRAINING INTENSITY

Getting Started with Heart Rate Monitoring

Heart rate monitoring can be useful to rowers of all levels, whether out of shape or competitive, novice or Olympian. Monitoring your heart rate allows you to maximize the effectiveness of your training time. It helps you adjust your effort so you can achieve the goals of each workout. For more information, talk to a local trainer or coach, check bookstores or call Concept2.

The following information, provided by Polar Electro, Inc., is designed to get you started with heart rate monitoring.

Medical authorities use the term "target zone" to describe the amount of physical activity which is enough to achieve fitness but not too much to exceed safe limits. This target zone is the level of activity which produces a heart rate of from 70–85% of the maximum attainable heart rate during all-out effort. (A rough formula for estimating your maximum heart rate is to subtract your age from 220.) Put in simple terms, your own heart rate can be used as a "speedometer" that tells you how much exercise your body needs for optimal physical fitness.

The following Target Range Chart is based on averages and can only be used as a guideline. For more accurate information, consult your doctor.

Note: Before beginning any type of exercise program, consult your doctor if you are over 35 years of age, have not been following a regular exercise program, smoke, have high blood pressure or high cholesterol, or use a pacemaker.

TARGET RANGE CHART

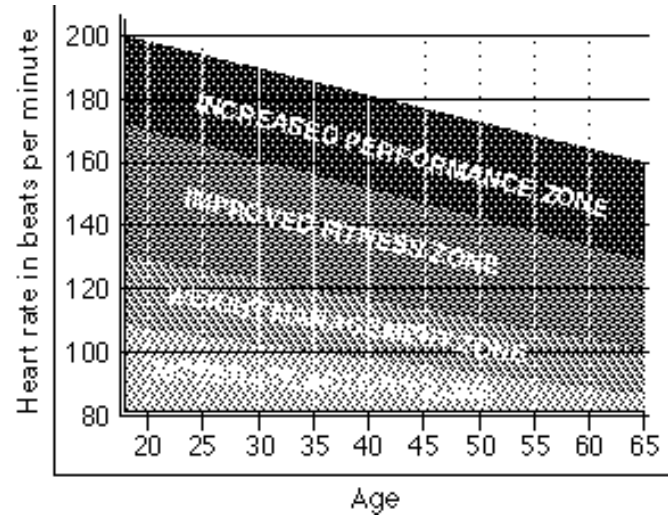

When you begin your exercise program, try to stay at the lower end of your target zone. As your fitness level improves, vary your exercise duration and intensity.

Choose your target zone according to your personal fitness goals. If your goal is weight management, high intensity, hard exercise is not necessary to burn fat effectively. (See the WEIGHT MANAGEMENT ZONE)

Exercising in the INCREASED PERFORMANCE ZONE (Above 85% of your maximum heart rate) is only necessary for competitive athletes.

EXERCISE DURATION AND FREQUENCY

Fitness experts advise that workouts should last approximately 30 to 40 minutes and be done at least 3 times a week. Your workouts should be spread throughout the week to let your body recover properly. Polar heart rate monitors guide you through your workout giving you continuous ECG-accurate heart rate readings.

TARGET ZONE EXERCISE PATTERN (40 year old)

Begin each workout slowly and give your body a chance to warm up at least 5 minutes below your target zone. Gradually increase the intensity of your exercise until you

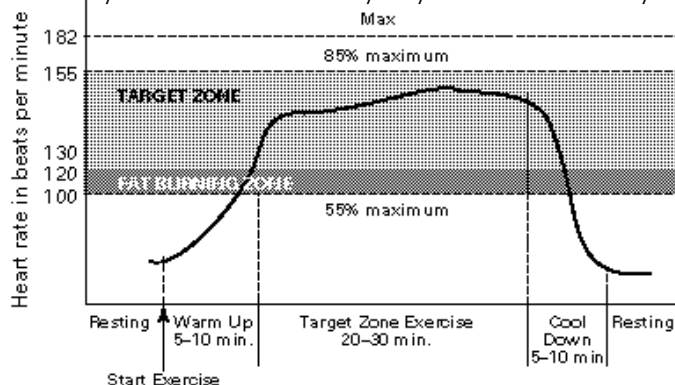

DISCLAIMER

The material in this manual is for information purposes only. The product it describes is subject to change without notice. Neither Polar Electro Inc. or Polar Electro Oy makes any representations or warranties with respect to this manual or, except as stated in the warranty, with respect to the product described herein. In no event shall either Polar Electro Inc. or Polar Electro Oy be liable for any damages, direct or incidental, consequential or special, arising out of or related to the use of this manual or the products described herein.

Copyright © 1997 Polar Electro Inc.

The charts and information in this section have been reprinted with permission from Polar Electro, Inc.

CARE AND MAINTENANCE

NOTE: Any service done by a party other than Polar Electro Inc. or a Polar authorized service center during the warranty period voids the warranty.

The Belt Transmitter consists of an elastic chest belt and **integral molded transmitter** with electrodes which automatically activates when properly wetted and secured around your chest. The transmitter will shut off automatically when removed, however, sweat and moisture can keep the Belt Transmitter activated so it is important to wipe it dry after each use.

Clean the Belt Transmitter with mild soap and water regularly to remove any perspiration residue. Do not use abrasives or chemicals such as steel wool or alcohol in cleaning as they can cause permanent damage to the electrodes.

Belt Transmitter Battery: The estimated battery life is 2500 hours of use. When your Belt Transmitter Battery is depleted, contact Polar Electro Inc. or a Polar Electro Inc. authorized service center to obtain a replacement.

LIMITED ONE YEAR WARRANTY

Non-commercial Applications

Polar Electro, Inc. warrants to the original consumer that the product will be free from defect in material or workmanship from the period of date of purchase indicated below:

- One piece (inclusive of battery)
waterproof Transmitter/Belt (PE40)----- 2 years
- Plug in Receiver----- 1 year

Commercial Applications

Polar warrants to the original consumer that the products will be free from defect in material or workmanship for 90 days from the date of purchase.

SERVICE

- Carefully pack your Receiver and Belt Transmitter in a shipping carton so that it is protected from shipping damage.
- Include a proof of purchase (a receipt or photocopy).
- Include a single sheet of paper stating why your HRM is being returned for repair. Print your Name, Address and Daytime Telephone Number.
- During the warranty period the product will be repaired or replaced, at Polar's option, without charge by Polar Electro Inc. or a Polar Electro Inc. authorized service center. There is a charge to cover the return shipping and handling of warranty repairs (this is not a repair charge). Additional shipping charges are required for warranty repairs returned to destinations outside the United States.
- Ship postage prepaid to:
Polar Electro Inc.
370 Crossways Park Drive
Woodbury, NY 11797-2050
Phone: 800.227.1314
Fax: 516.364.5454
- All HRM's are returned to the owner by regular UPS (Polar Electro Inc. will not ship to post office boxes). Priority shipping requests require additional fees.

TRAINING ON THE CONCEPT2 INDOOR ROWER

1) DETERMINE YOUR GOALS

They may be one or more of the following:

- to lose some weight
- to maintain general health and fitness
- to aid in rehabilitation
- to cross-train for another sport
- to train for competitive rowing

2) BEGIN YOUR EXERCISE PROGRAM

Here are some basic guidelines for setting up an exercise program to achieve your goals.

Weight Loss:

Frequency: 5–6 times per week

Duration: 20–50 minutes

Intensity: Steady effort, able to carry on a conversation; intervals for variety

Sample Workouts:

- 5000mC or longer
- 30minC or longer
- alternate: 1minM, 1minR for at least 20 minutes total

Maintain General Health and Fitness:

Frequency: 3–5 times per week; alternate with other types of exercise if desired.

Duration: At least 20 minutes

Intensity: Moderate steady work, target heart rate

Sample Workouts:

- 20–30minM
- 4000–6000mM
- alternate: 40secH, 20secR for 15–20min
- alternate: 1minH, 1minR for at least 20min total

To Aid in Rehabilitation: Work with a doctor or rehab specialist to develop an exercise plan that will meet your needs.

To Cross-Train for Another Sport: Your program will vary depending on the nature and yearly cycle of your major sport.

Frequency: 2–4 times per week in your “off-season”, 1–2 times per week in competitive season

Duration: 30–60 minutes – shorter for intense, speed workouts; longer for steady state aerobic workouts

Intensity: Include steady state, anaerobic threshold work also more intense intervals, racing pieces

Sample Workouts:

- 40minM
- 10,000mM
- alternate: 1minH, 1minR for 30–40min
- pyramid: 1minH, 30secR, 2minH, 30secR, 3minH, 30secR, 4minH, 30secR, 3minH, 30secR, 2minH, 30secR, 1minH, 30secR.
- repeat: 3minM@18spm, 2 minM@24spm, 1minM@28spm, for a total time of 30–60min

KEY:

m = meters

min = minutes

sec = seconds

spm = strokes per minute

x = times (example: 3x
500m means 3 repetitions of 500 meters or row 500 meters 3 times)

R = easy, restful rowing

C = conversational intensity (able to carry on a conversation comfortably)

M = moderate intensity (barely able to carry on a conversation)

H = high intensity

RP = 2000m race pace

RPF(3–4sec) = 3 to 4 seconds faster than race pace

RPS(5–7sec) = 5 to 7 seconds slower than race pace

To Train for Competitive Rowing: If you do not have a coach or a club program to follow, here’s a basic plan.

Frequency: 4–6 times per week (less when you are rowing on the water)

Duration: 20–60 minutes depending on the intensity of the workout

Intensity: the whole range, from racing to easy steady state

Sample Workouts:

- 2 sets of: 10 repetitions of: [20secRPF(8–10sec), 40secR] with 5–7minR between the sets
- 2 sets of: 3 repetitions of: [2minRPF(2–4sec), 1minR] with 5–7minR between the sets
- 3 x 1500mRP with 5minR between pieces
- 3000–4000mRPS(2–4 sec)
- 30minRPS(5–7sec)
- 60minRPS(8–12sec)
- repeat: 3minM@18spm, 2minM@24spm, 1minM@30spm for a total time of 30–60min

3) MONITOR YOUR PROGRESS

We encourage you to record your workouts in a log. At a minimum, you should record your periodic test pieces in order to monitor your progress toward your goals. A sample Test Results Log is provided on page 27. You may also wish to keep a monthly summary of workouts such as the one provided on page 26. This type of log helps give you an overview of the workouts you have been doing. It’s also a good place to record your total meters rowed in case you ever want to join the Concept2 Million Meter Club. Finally, the most detailed log option is a daily log page which allows you to record a maximum of information about each of your workout sessions. We have included an example on page 25. Please feel free to make as many copies of these pages as you wish. You can also request a free logbook from Concept2

4) EVALUATE AND ADJUST PROGRAM IF NECESSARY

If you are not making progress toward your goals, you may need to modify your program. It may be helpful to discuss your training with a coach or fellow athlete. If you are tired and your performance is getting worse, you may actually be training too hard.

NOTE: Additional rowing information is available at www.concept2.com, as well as in our free Training Guide provided with your Indoor Rower.

THE ROWER'S DAILY LOG

PERSONAL DATA			
Date:	Form of Exercise:		Workout Partners:
Time of Day:	<input type="checkbox"/> Indoor	<input type="checkbox"/> On-Water Rowing	<input type="checkbox"/> Other:
Environmental conditions for workout:	<input type="checkbox"/> hot <input type="checkbox"/> cold <input type="checkbox"/> just right <input type="checkbox"/> humid <input type="checkbox"/> dry	Before workout, my energy level was: <input type="checkbox"/> low, unmotivated <input type="checkbox"/> in-between <input type="checkbox"/> ok, somewhat motivated <input type="checkbox"/> energetic, highly motivated	And my mood was: <input type="checkbox"/> bad, grumpy <input type="checkbox"/> stressed out <input type="checkbox"/> just OK <input type="checkbox"/> good <input type="checkbox"/> great
Notes:	Notes:	Notes:	Notes:
Body Weight pre-workout: _____ post-workout: _____		Heart Rate Resting a.m.: _____ pre-workout: _____	
Today's Workout:		Goals:	
How it felt, and other comments:			

WORKOUT DATA										
Interval/Split	1	2	3	4	5	6	7	8	9	10
Data: Meters										
Pace, Watts, or Calories										
Heart Rate/Stroke Rate										
Other:										
More data:	11	12	13	14	15	16	17	18	19	20
Meters										
Pace, Watts, or Calories										
Heart Rate/Stroke Rate										
Other:										

CUMULATIVE DATA						
	Indoor Rowing Meters	Indoor Rowing Time	On-Water Mileage	On-Water Time	Other: Distance	Other: Time
TODAY'S TOTAL						
CUMULATIVE TO DATE						
OTHER CUMULATIVE DATA:						

Suggestions for next time I do this workout:



TEST RESULTS LOG

Test Piece: 2000 METERS

Test Date	Distance/Time	Comments

Test Piece: 30 MINUTE

Test Date	Distance/Time	Comments

Test Piece: 60 MINUTE

Test Date	Distance/Time	Comments

CONCEPT2 INDOOR ROWER PACE CHART

Use this chart to predict your final time or distance for the workouts shown.

Avg pace per

500m	1000m	2000m	5000m	6000m	10,000m	30 min.	60 min.
1:28	2:56	5:52	14:40	17:36	29:20	10,230	20,460
1:30	3:00	6:00	15:00	18:00	30:00	10,000	20,000
1:32	3:04	6:08	15:20	18:24	30:40	9780	19,560
1:34	3:08	6:16	15:40	18:48	31:20	9570	19,140
1:36	3:12	6:24	16:00	19:12	32:00	9380	18,760
1:38	3:16	6:32	16:20	19:36	32:40	9180	18,360
1:40	3:20	6:40	16:40	20:00	33:20	9000	18,000
1:42	3:24	6:48	17:00	20:24	34:00	8820	17,640
1:44	3:28	6:56	17:20	20:48	34:40	8650	17,300
1:46	3:32	7:04	17:40	21:12	35:20	8490	16,980
1:48	3:36	7:12	18:00	21:36	36:00	8330	16,660
1:50	3:40	7:20	18:20	22:00	36:40	8180	16,360
1:52	3:44	7:28	18:40	22:24	37:20	8040	16,080
1:54	3:48	7:36	19:00	22:48	38:00	7890	15,780
1:56	3:52	7:44	19:20	23:12	38:40	7760	15,520
1:58	3:56	7:52	19:40	23:36	39:20	7630	15,260
2:00	4:00	8:00	20:00	24:00	40:00	7500	15,000
2:02	4:04	8:08	20:20	24:24	40:40	7380	14,760
2:04	4:08	8:16	20:40	24:48	41:20	7260	14,520
2:06	4:12	8:24	21:00	25:12	42:00	7140	14,280
2:08	4:16	8:32	21:20	25:36	42:40	7030	14,060
2:10	4:20	8:40	21:40	26:00	43:20	6920	13,840
2:12	4:24	8:48	22:00	26:24	44:00	6820	13,640
2:14	4:28	8:56	22:20	26:48	44:40	6720	13,440
2:16	4:32	9:04	22:40	27:12	45:20	6620	13,240
2:18	4:36	9:12	23:00	27:36	46:00	6520	13,040
2:20	4:40	9:20	23:20	28:00	46:40	6430	12,860
2:22	4:44	9:28	23:40	28:24	47:20	6340	12,680
2:24	4:48	9:36	24:00	28:48	48:00	6250	12,500
2:26	4:52	9:44	24:20	29:12	48:40	6160	12,320
2:28	4:56	9:52	24:40	29:36	49:20	6080	12,160
2:30	5:00	10:00	25:00	30:00	50:00	6000	12,000

RECOMMENDED MAINTENANCE SCHEDULE

Daily:

Wipe monorail with a cloth or non-abrasive scouring pad after use.
See page 30.

Every 50 hours of use (weekly for institutional users):

Clean and lubricate the chain with the oil provided (or 20w Motor Oil or 20w 3-in-1 oil). See page 30.

Every 250 hours of use (monthly for institutional users):

- 1) Inspect chain for stiff links. If thorough lubrication does not help, the chain should be replaced with Concept2 part number PN 1765.
- 2) Inspect chain-handle connection for wear. If the hole has become elongated, or the U-bolt is worn halfway through, the entire connection should be replaced with Concept2 part number PN 184.
- 3) Tighten the shock cord if the handle does not return all the way to the fan enclosure. See page 32.
- 4) Check the socket screws used to install the front leg for tightness.
- 5) Loosen or tighten the nuts on the Performance Monitor arm joints as necessary. See page 35.
- 6) Check for dust inside flywheel with flashlight. Vacuum if needed. See page 34.

Approximately Every 800 Hours of Use:

Replace batteries in the Performance Monitor (PM2). The PM2 uses 2 AA batteries. See page 35.

IMPORTANT: The monitor is a sealed unit. Do NOT take apart. Any attempt to disassemble will void warranty. Contact Concept2 for problems with this part.



MAINTENANCE

IMPORTANT SAFETY NOTE

Use of this machine with a worn or weakened part, such as the chain, sprockets, swivel connector or shock cord, may result in injury to the user. When in doubt about the condition of any part, Concept2 strongly advises that it be replaced immediately. Use only genuine Concept2 parts. Use of other parts may result in injury or poor performance of machine.

CLEANING MONORAIL TOP

Clean daily after use

Tools Needed:

Cloth

Cleaner: soap & water
or any glass cleaner

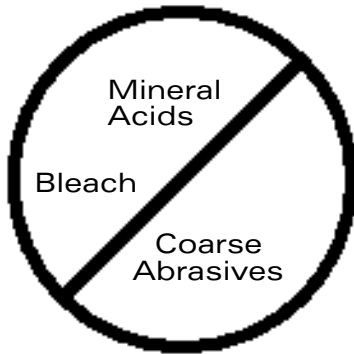

LUBRICATING CHAIN

Every 50 Hours of Use

Use 1 teaspoon of 20 weight oil on paper towel.
Rub along chain.

Wipe off excess.

Repeat if needed.

1.



2.

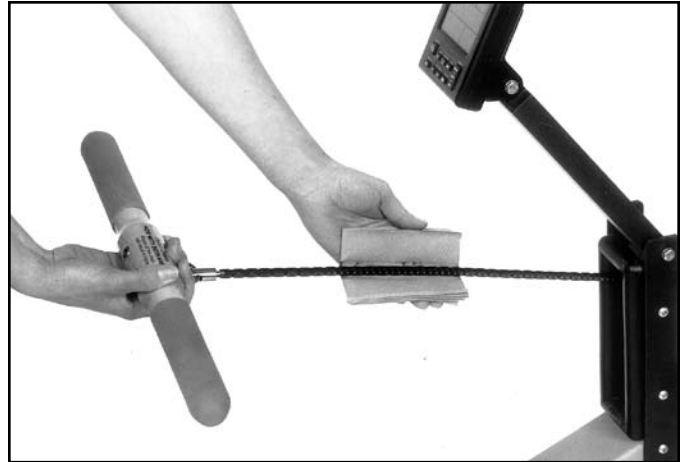

3.



REMOVING AND INSTALLING THE RETURN MECHANISM COVER

Concept2 part number PN 1526

Removing



Installing



Assembled



SHOCK CORD ADJUSTMENT

You must use the shock cord available through Concept2. Use of other shock cord will have a significant effect on the performance of your machine. Concept2 part number PN 1731.



1. Detach flywheel section and turn upside down.

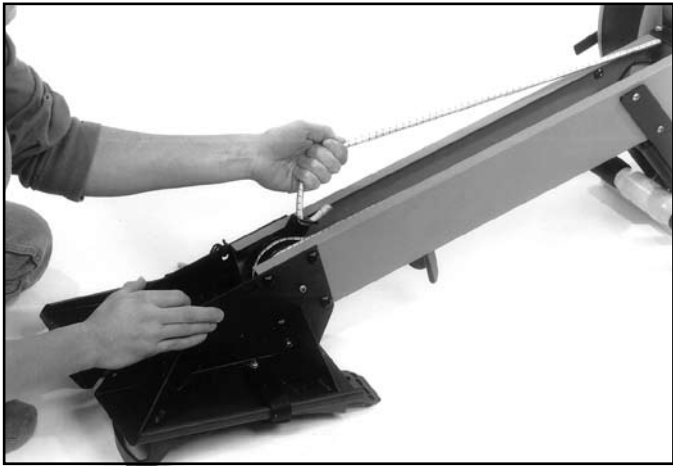

2.

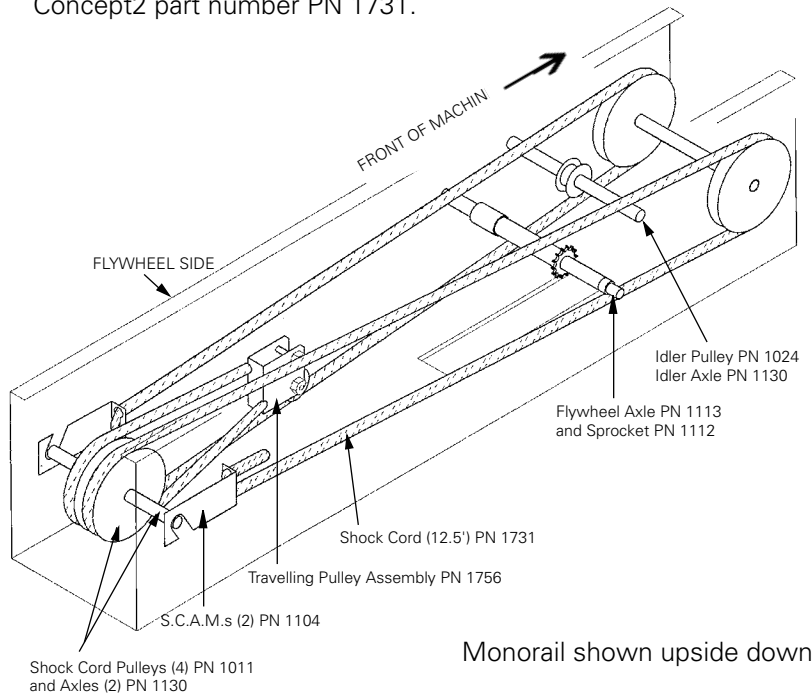

Monorail shown upside down.

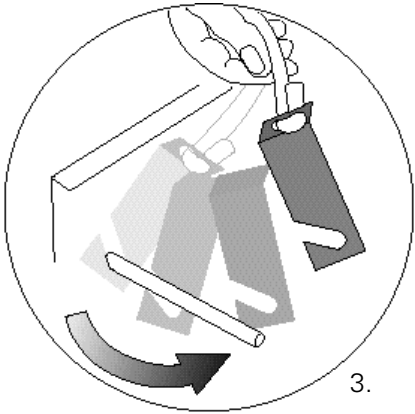

3.

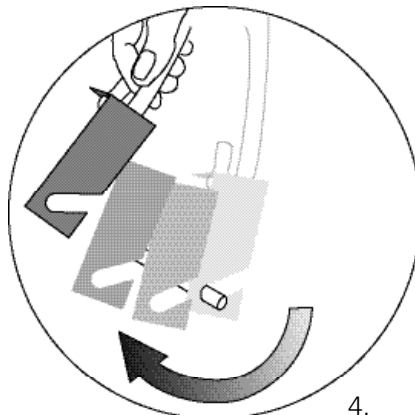
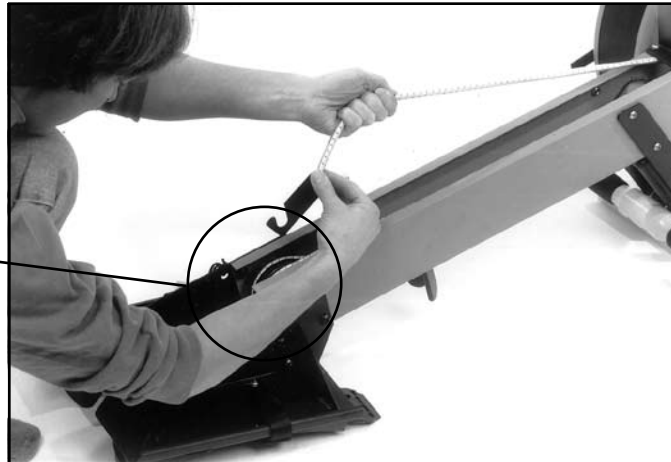

4.

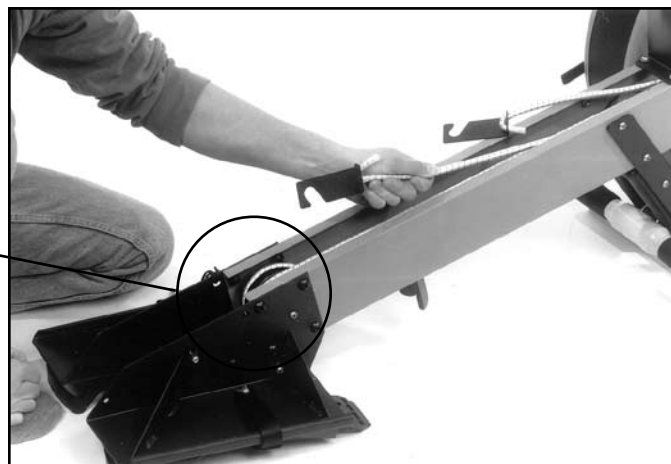

5.

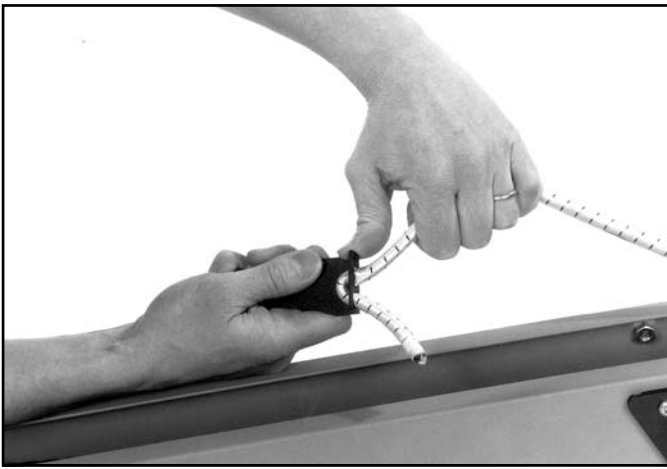

7.

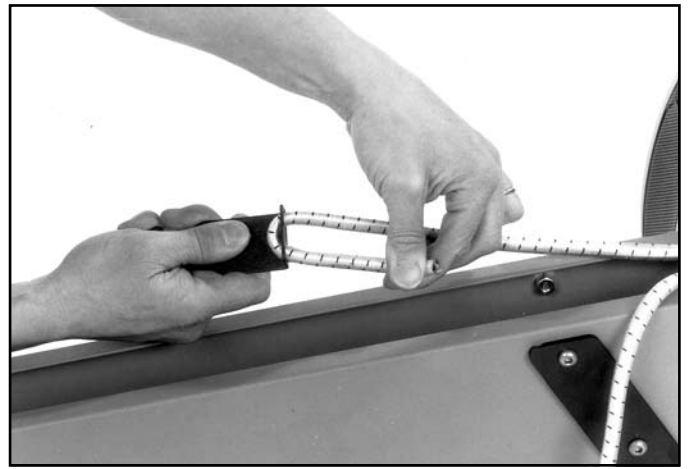

Push equal amounts of cord through both shock cord adjustment mechanisms.

6.

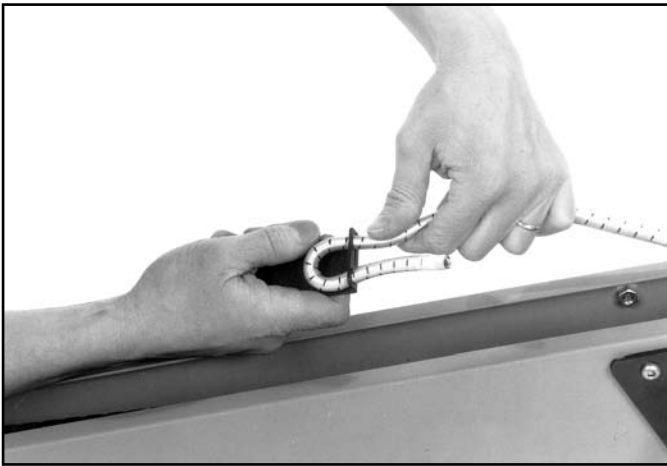

8.

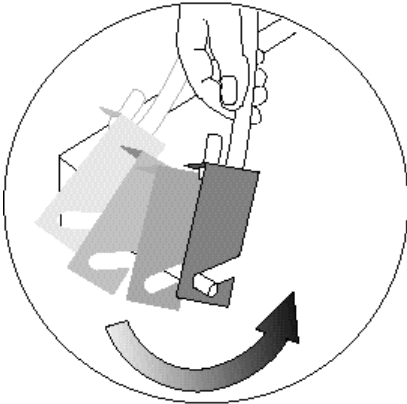

9.

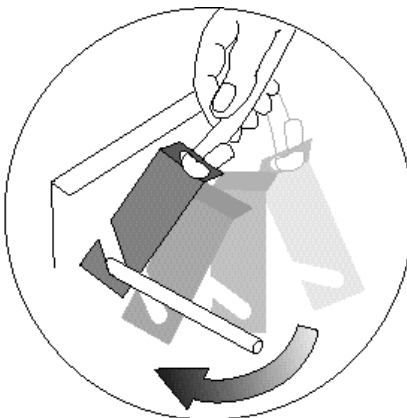
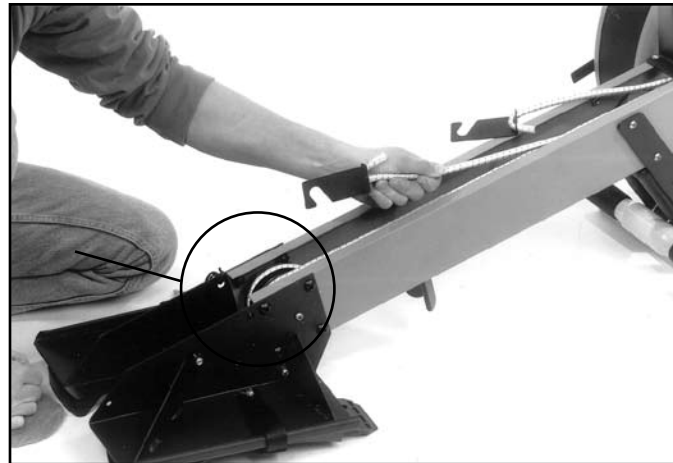

10.



FLYWHEEL OPENING AND CLEANING

Every 250 Hours of Use

Tools Needed:

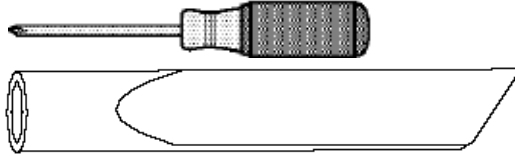

Check for dust with flashlight. Vacuum if needed.

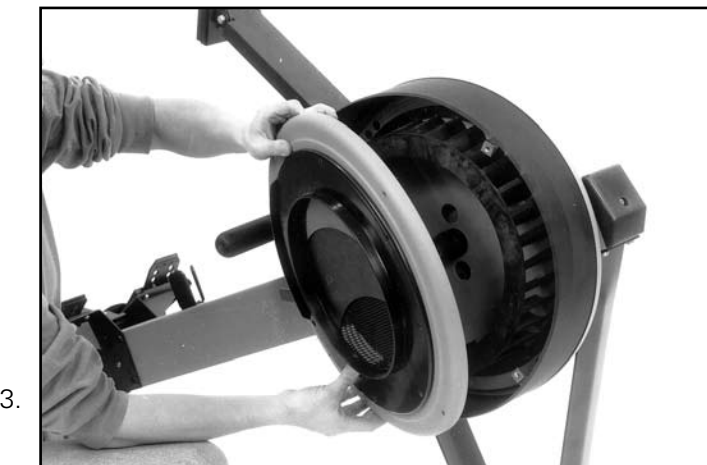
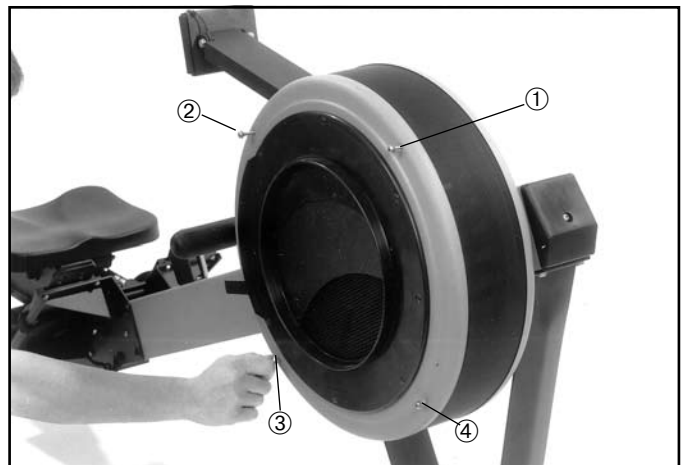
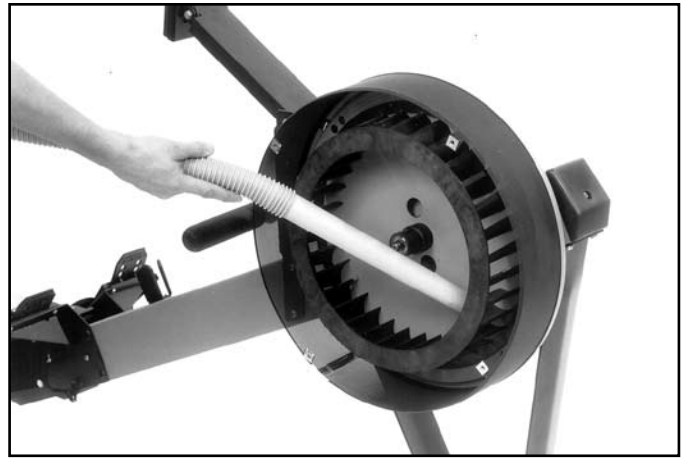

BATTERY REMOVAL

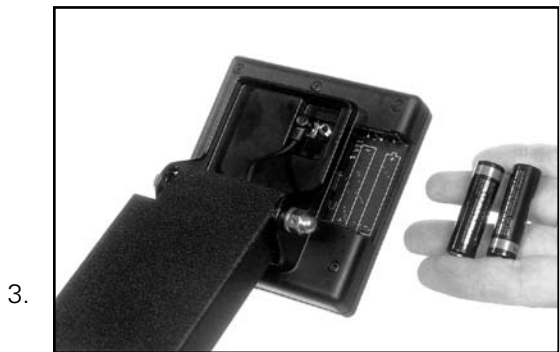

BATTERY REPLACEMENT

Use 2 AA batteries.

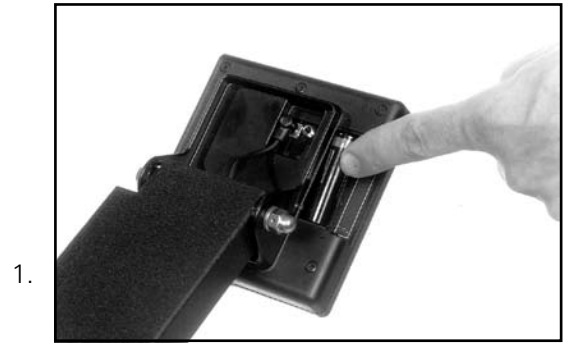

PERFORMANCE MONITOR ARM TENSION ADJUSTMENT

Tools Needed:

2 wrenches: 7/16" or 11mm



TROUBLESHOOTING

New problems may arise that are not dealt with in this troubleshooting section. We would appreciate any input you, our customer, may have to help us deal with these situations. Please call or write us.

- **Symptom:** Scraping noise from inside the front end beam.

Possible Cause: Shock cord or chain may be routed incorrectly or worn. Shock cord or chain may have jumped off the pulley.

Remedy: See diagram on page 2 for proper routing of the shock cord and chain. Contact Concept2 if replacement parts are needed.

- **Symptom:** Creaking noise from the footplate area.

Possible Cause: Two mating surfaces of monorail and front end are working against each other.

Remedy: Separate the monorail from the front end. Apply a light coat of thick lubricant (Vaseline or Chap-stick) to front facing and bottom rear facing aluminum hooks located at front of monorail. Reassemble and row.

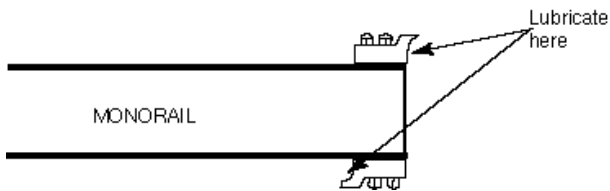

- **Symptom:** Seat sticks on monorail.

Possible Cause # 1: Monorail may not be clean.

Remedy: Clean monorail. See page 30.

Possible Cause # 2: Bottom rollers are too tight.

Remedy: Adjust with a $\frac{9}{16}$ " or 14 mm wrench.

- **Symptom:** Seat is bumpy as it rolls.

Possible Cause: Dirt on seat rollers or monorail, or worn out seat rollers.

Remedy: Clean rollers and monorail. Replace seat rollers if worn out. (Concept2 part number PN 1724)

- **Symptom:** Chain skips on sprocket during the drive or runs roughly during the recovery.

Possible Cause # 1: Stiff links in chain.

Remedy: Clean and lubricate the chain. See page 30. If it continues to skip, the machine should not be rowed and you should contact Concept2 immediately.

Possible Cause # 2: Worn out sprocket.

Remedy: Replace sprocket with PN 1112 from Concept2.

- **Symptom:** Handle does not retract all the way to the chain guard and hangs loose.

Possible Cause: Shock cord is too loose due to normal stretching or cold temperatures.

Remedy: Adjust shock cord tension. See page 31. Replace shock cord if it is frayed through outer cover or if it is losing its elasticity. Order Concept2 part number PN 1731. If the shock cord is cold, allow it to warm up.

- **Symptom:** Seat hits the end of the track while rowing. NOTE: it is possible that you will hit the end of the monorail while just sitting, but not while actually rowing. We recommend that you try a test row before making adjustments.

Possible Cause: Long Legs!

Remedy: If you hit the end of the monorail while rowing with the seat rollers in the standard position, you can extend the travel distance of the seat by 1 inch.

- 1) Use two $\frac{9}{16}$ " or 14mm wrenches to loosen the bolt holding the rear top seat roller in the seat carriage (see drawing). Remove the roller and hardware from hole A. Note the order of hardware.
- 2) Place the roller and hardware in hole B in the same order in which you removed it. Tighten the nut.

- **Symptom:** The seat wobbles from side to side on the monorail.

Possible Cause: After extended use, the fit of the seat on the monorail may become loose due to wear on the rollers.

Remedy: You may move the bottom roller to a tighter hole toward the front of the seat (C) as shown in the drawing below by following steps A or B.

- A. The top roller must be removed and the seat slid up to front of monorail and off. Use two $\frac{9}{16}$ " or 14mm wrenches to do this. Use a $\frac{9}{16}$ " wrench and an allen wrench to loosen and tighten the bottom rollers.

OR

- B. The top of the rear leg must be removed from the monorail using a $\frac{7}{16}$ " wrench and an allen wrench. The seat can then be slid off the rear of the monorail. Use a $\frac{9}{16}$ " wrench and an allen wrench to loosen and tighten the bottom rollers.

Pictured instructions are available.

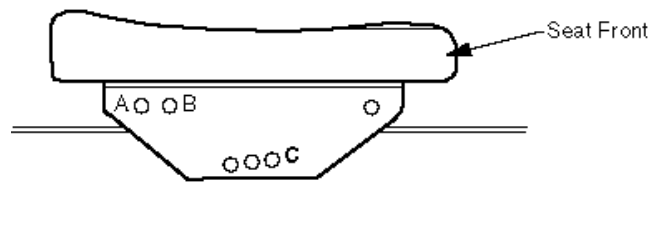

- **Symptom:** Monitor display fails to come on when you start to row.

Possible Cause # 1: If you just changed the batteries, they may be in upside down.

Remedy 1: Try reversing the orientation of the batteries. See page 35.

Remedy 2: If you have not just changed the batteries, try pressing the ON/OFF button. If there is still no life in the display, you could try new batteries. If this doesn't help, contact Concept2. If the ON/OFF button does activate the display (with zeroes), there may be a problem with the monitor pickup.

Possible Cause # 2: Performance Monitor pickup wire may not be securely plugged in on back of monitor.

Remedy: Make sure the plug is inserted completely.

- **Symptom:** Faded or incomplete segments on the PM2 display.

Possible Cause: Poor connection between LCD and circuit board.

Remedy: Perform the self-test as shown on page 19 and call Concept2 toll free at 1.800.245.5676.

- **Symptom:** Entire monitor screen (not just Heart Rate display) goes blank when the Heart Rate cable is plugged in.

Possible Cause: A short circuit that occurs if the Heart Rate cable is plugged into the PM2 while the monitor is turned ON.

Remedy: Push the ON/OFF button once to turn the PM2 off, then push the ON/OFF button again to turn the PM2 back on again. We suggest that the Heart Rate cable be plugged into the monitor when the PM2 is turned off.

- **Symptom:** The heart rate reading is erratic or is totally absent.

NOTE: Occasionally the Heart Rate Monitor will pick up bad data for a number of reasons. When the PM2 recognizes bad data, the display will go blank rather than show the bad data. It will take 5 seconds or longer to reestablish and display accurate readings.

Possible Cause # 1: Poor contact between skin and electrodes.

Remedy 1: Repeat the electrode wetting procedure (see page 21). The electrodes must be wet to pick up accurate heart rate readings.

Remedy 2: Make sure the transmitter is centered with electrodes flat against your skin, as high under the pectoral muscles as is comfortable.

Remedy 3: Wash your belt transmitter with mild soap and water, if you have not been doing so regularly.

Possible Cause # 2: Receiver too far away from transmitter.

Remedy: Make sure your Receiver is within the proper range to receive transmission (1 meter/3 feet from your chest belt).

Possible Cause # 3: Bad cable connections

Remedy: Check the connection on the back of the PM2 where the receiver cable plugs in. Check the connection between the cable and the receiver.

Possible Cause # 4: Outside interference

Remedy: If you are exercising within range of strong electromagnetic signals the heart rate readings may elevate to abnormal levels. Common sources of electromagnetic signals are televisions, computers, cars, TV antennas, high voltage power lines and motor driven exercise equipment.

Possible Cause # 5: Signals from more than one Belt Transmitter within the transmission range (1 meter/3 feet) may also cause incorrect readings.

Remedy: Check your surroundings and move away from the source of interference if possible.

NOTE: Two Indoor Rowers with heart rate hardware must be at least 4 feet (1.22 meters) apart to avoid interference.

Schematics for all parts of the Indoor Rower and detailed instructions for repair and/or replacement of parts are available.

In the event you may have questions or problems or if further troubleshooting assistance is needed, please call Concept2 toll free at 1.800.245.5676 in the USA and Canada.

6

TROUBLE-SHOOTING



MORRISVILLE, VERMONT USA EMAIL:ROWING@CONCEPT2.COM WEB:WWW.CONCEPT2.COM